

What's inside...

Carefully curated products for protecting and safely storing a vast array of archival collection materials.

| | |
|--|-------|
| Document Storage | 14-18 |
| Primary Enclosures | 19-24 |
| Pamphlet Storage | 25-27 |
| Preservation Supplies..... | 28-30 |
| Photographic Supplies & Equipment..... | 31-39 |
| Specialty Storage | 40-45 |
| Cabinets..... | 46 |



All products labeled **SafePack** are packaged in **acid-free** shrink wrap to preserve archival integrity and protect against dust, dirt, moisture, and fingerprints.

Specifications

- 60-pt. barrier board
- Acid-free, lignin-free
- 8.0-9.0 pH
- Gray/white, tan, or black
- 3% calcium carbonate buffer
- P. A.T. Certified



Document Cases

Designed for long-term storage

- Exposed serrated edge to reduce chance of injury
- Shrink-wrapped with polyethylene to preserve archival integrity
- One-piece scuff-resistant cases feature a hinged lid for quick and easy access to materials
- Metal-reinforced edges add stacking strength and durability
- All cases feature a pull string for easy removal from storage shelf
- Choose from standard or extra-deep cases

GRAY/WHITE DOCUMENT CASES

| CAT.# | H x W x D | LBS. |
|------------|----------------------------|------|
| 38 362 001 | 10 3/4" x 12 3/4" x 2 1/2" | 0.60 |
| 38 362 002 | 10 3/4" x 12 3/4" x 5" | 0.80 |
| 38 362 003 | 10 3/4" x 15 1/2" x 2 1/2" | 0.70 |
| 38 362 004 | 10 3/4" x 15 1/2" x 5" | 2.10 |
| 38 362 005 | 12 1/2" x 15 1/2" x 5" | |

TAN DOCUMENT CASES

| CAT.# | H x W x D | LBS. |
|------------|----------------------------|------|
| 38 363 001 | 10 3/4" x 12 3/4" x 2 1/2" | 0.60 |
| 38 363 002 | 10 3/4" x 12 3/4" x 5" | 0.80 |
| 38 363 005 | 12 1/2" x 15 1/2" x 5" | 2.10 |

BLACK DOCUMENT CASES

| CAT.# | H x W x D | LBS. |
|------------|----------------------------|------|
| 38 367 001 | 10 3/4" x 12 3/4" x 2 1/2" | 0.60 |
| 38 367 002 | 10 3/4" x 12 3/4" x 5" | 0.80 |
| 38 367 005 | 12 1/2" x 15 1/2" x 5" | 2.10 |

EXTRA-DEEP GRAY/WHITE DOCUMENT CASES

| CAT.# | DESCRIPTION | H x W x D |
|------------|-------------|------------------------|
| 38 368 001 | Letter | 10 3/4" x 12 3/4" x 7" |
| 38 368 002 | Legal | 10 3/4" x 15 1/2" x 7" |

Specifications

- 50-pt. barrier board
- Acid-free, lignin-free
- 8.0-9.0 pH
- Gray/white or tan
- 3% calcium carbonate buffer
- P. A.T. Certified

Tyvek® Laminated Document Storage Cases

Superior flex-fold strength

- Exposed serrated edge to reduce chance of injury
- Shrink-wrapped with polyethylene to preserve archival integrity
- Constructed of 50-pt. barrier board covered with archival-safe Tyvek® laminate
- Excellent tear- and water-resistant properties
- Resist mildew and rot, remain pH-neutral, and are fully recyclable



GRAY/WHITE LAMINATED CASES

| CAT.# | H x W x D | LBS. |
|------------|----------------------------|------|
| 38 362 101 | 10 3/4" x 12 3/4" x 2 1/2" | 0.60 |
| 38 362 102 | 10 3/4" x 12 3/4" x 5" | 0.80 |
| 38 362 103 | 10 3/4" x 15 1/2" x 2 1/2" | 0.70 |
| 38 362 104 | 10 3/4" x 15 1/2" x 5" | 0.90 |
| 38 362 105 | 12 1/2" x 15 1/2" x 5" | 2.10 |
| 38 368 101 | 10 3/4" x 12 3/4" x 7" | 1.00 |
| 38 368 102 | 10 3/4" x 15 1/2" x 7" | 1.20 |

TAN LAMINATED CASES

| CAT.# | H x W x D | LBS. |
|------------|----------------------------|------|
| 38 363 101 | 10 3/4" x 12 3/4" x 2 1/2" | 0.60 |
| 38 363 103 | 10 3/4" x 15 1/2" x 2 1/2" | 0.70 |
| 38 363 104 | 10 3/4" x 15 1/2" x 5" | 0.90 |
| 38 363 105 | 12 1/2" x 15 1/2" x 5" | 2.10 |

Specifications

- B-flute gray stone corrugated board
- Acid-free, lignin-free
- 8.0-9.0 pH
- 3% calcium carbonate buffer
- P.A.T. Certified



Document Cases

Designed for economical long-term storage

- Flip-top lid keeps documents free from dust, dirt, and fingerprints, yet allows quick access
- Locking tabs on each side keep lid shut when not in use
- Choose acrylic-coated board that repels moisture, or uncoated
- Cases ship flat and ready to assemble

ACRYLIC COATED

| CAT.# | H x W x D | LBS. |
|------------|----------------------------|------|
| 49 546 001 | 10 1/2" x 12 1/2" x 2 1/2" | 0.40 |
| 49 546 002 | 10 1/2" x 12 1/2" x 5" | 0.50 |
| 49 546 003 | 10 1/2" x 15 1/2" x 2 1/2" | 0.50 |
| 49 546 004 | 10 1/2" x 15 1/2" x 5" | 0.70 |
| 49 546 005 | 12 1/2" x 15 1/2" x 5" | 1.00 |

UNCOATED

| CAT.# | H x W x D | LBS. |
|------------|----------------------------|------|
| 49 546 101 | 10 1/2" x 12 1/2" x 2 1/2" | 0.40 |
| 49 546 102 | 10 1/2" x 12 1/2" x 5" | 0.50 |
| 49 546 104 | 10 1/2" x 15 1/2" x 5" | 0.70 |
| 49 546 105 | 12 1/2" x 15 1/2" x 5" | 1.00 |

Specifications

- 3-mil copolymer of polypropylene and polyethylene
- pH-neutral
- Chemically stable

Coroplast™ Document Cases

Rigid stacking strength; washable

- One-piece corrugated plastic cases
 - Resist heat and moisture
- Ship flat and ready to assemble.



| CAT.# | H x W x D | LBS. |
|------------|------------------------|------|
| 49 475 001 | 10 1/2" x 12 1/2" x 5" | 0.70 |
| 49 475 002 | 10 1/2" x 15 1/2" x 5" | 0.80 |

Document Carton Dividers



Rigid dividers can also be used as temporary "file out" cards

- White, acid-free corrugated dividers are pH-neutral
- 1/3 cut to sort and identify stored materials
- 15 dividers per package (1.00 lb.)

| CAT.# | DESCRIPTION | H x W |
|------------|-------------|-------------------|
| 49 455 001 | Letter | 10 1/2" x 12 1/2" |
| 49 455 002 | Legal | 10 1/2" x 15 1/2" |

Document Support Spacers

Pre-scored to adjust easily to document



- Acid-free, corrugated board spacers are pH-neutral
- Gray spacers are P.A.T. Certified
- Keep materials upright to prevent damage and curling during storage (0.20 lb.)

| CAT.# | DESCRIPTION | H x W |
|------------|--------------|------------------|
| 49 454 001 | White Letter | 8" x 20" |
| 49 454 002 | White Legal | 9 1/2" x 30 1/2" |
| 49 160 001 | Gray Letter | 8" x 20" |
| 49 160 002 | Gray Legal | 9 1/2" x 30 1/2" |

Specifications

- B-flute gray stone corrugated board
- Acid-free, lignin-free
- 8.0-9.0 pH
- 3% calcium carbonate buffer
- P.A.T. Certified



Storage Cartons

Choose acrylic-coated to repel moisture, or uncoated

- Cartons are constructed of heavy-duty corrugated board with shallow lids and hand cut-outs for easy transport
- All cartons ship flat and ready to assemble

ACRYLIC COATED

| CAT.# | DESCRIPTION | H x W x D | LBS. |
|------------|------------------|------------------|------|
| 49 548 001 | Full-Size | 10" x 15" x 12" | 1.10 |
| 49 548 002 | Letter Half-Size | 10" x 12½" x 6½" | 0.80 |
| 49 548 003 | Legal Half-Size | 10" x 15½" x 6½" | .80 |

UNCOATED

| CAT.# | DESCRIPTION | H x W x D | LBS. |
|------------|------------------|------------------|------|
| 49 548 101 | Full-Size | 10" x 15" x 12" | 1.10 |
| 49 548 102 | Letter Half-Size | 10" x 12½" x 6½" | 0.80 |
| 49 548 103 | Legal Half-Size | 10" x 15½" x 6½" | 0.80 |

Specifications

- B-flute gray stone corrugated board
- Acid-free, lignin-free
- 8.0-9.0 pH
- 3% calcium carbonate buffer
- P.A.T. Certified



Double-Wall Record Storage Box

Heavy-duty corrugated board construction with hinged lid

- Hand cut-outs for easy transport
- Ships flat and ready to assemble.

| CAT.# | H x W x D | LBS. |
|------------|-----------------|------|
| 49 005 001 | 10" x 15" x 12" | 1.30 |



Specifications

- Binders: 60-pt. barrier board
- Envelopes: 7-pt. buffered stock
- Acid-free, lignin-free
- P.A.T. Certified

Envelope Storage Binders

All adhesives are acid-free

- Gray/white binder covers are attached with black cloth tape
- Light cream envelopes are attached with single-stitched pH-neutral cambric cloth

| CAT.# | BINDER | ENVELOPE | LBS. |
|------------|-------------|------------|------|
| | H x W | H x W | |
| 38 425 001 | 10½" x 7½" | 10" x 7" | 3.80 |
| 38 425 002 | 12" x 9" | 11½" x 8½" | 4.10 |
| 38 425 003 | 12½" x 9½" | 12" x 9" | 4.10 |
| 38 425 004 | 13½" x 10½" | 13" x 10" | 4.10 |

Specifications

- 60-pt. barrier board or 50-pt. Tyvek® laminated barrier board
- Acid-free, lignin-free
- 8.0-9.0 pH
- Gray/white, tan, or black
- 3% calcium carbonate buffer
- P.A.T. Certified

Newspaper Boxes

Resist mildew and rot, remain pH-neutral, fully recyclable

- Safe, long-term two-piece storage boxes feature deep telescoping lids and metal-reinforced edges for stacking strength and durability
- Gray/white boxes also work well for storing posters, prints, and more
- 50-pt. Tyvek® laminated barrier board boxes provide excellent tear- and water-resistant properties, superior flex-fold strength
- Exposed serrated edge to reduce chance of injury
- Shrink-wrapped with polyethylene to preserve archival integrity

Same Day Shipping/SafePack



GRAY/WHITE

| CAT.# | H x W x D | LBS. |
|------------|------------------|------|
| 38 361 001 | 3" x 20½" x 24½" | 2.70 |
| 38 361 002 | 2" x 15" x 22" | 1.80 |
| 38 361 003 | 3" x 18" x 13" | 1.90 |
| 38 361 004 | 2½" x 19" x 25" | 2.40 |
| 38 361 005 | 3" x 23" x 31" | 3.10 |

GRAY/WHITE TYVEK® LAMINATED

| CAT.# | H x W x D | LBS. |
|------------|------------------|------|
| 38 361 102 | 2" x 15" x 22" | 1.80 |
| 38 361 104 | 2½" x 19" x 25" | 2.40 |
| 38 361 103 | 3" x 18" x 13" | 1.90 |
| 38 361 101 | 3" x 20½" x 24½" | 2.70 |

Specifications

- 60-pt. barrier board or 50-pt. Tyvek® laminated barrier board
- Acid-free, lignin-free
- 8.0-9.0 pH
- Gray/white, tan, or black
- 3% calcium carbonate buffer
- P.A.T. Certified



Drop-Front Boxes

Drop-front panel allows easy access to stored documents, photos, or prints

- Fully telescoping lid keeps out dust and dirt; choose from 60-pt. barrier board lid and 30-pt. clear textured polypropylene lid
- Boxes and lids both feature metal-reinforced edges for stacking strength and durability

- Tyvek® laminated 50-pt. barrier board boxes provide excellent tear- and water-resistant properties, superior flex-fold strength
- Exposed serrated edge to reduce chance of injury
- Shrink-wrapped with polyethylene to preserve archival integrity
- Resist mildew and rot, remain pH-neutral, fully recyclable

GRAY/WHITE TYVEK® LAMINATED

| CAT.# | H x W x D | LBS. |
|------------|------------------|------|
| 38 360 204 | 3" x 12½" x 9½" | 2.00 |
| 38 360 209 | 3" x 14½" x 18½" | 1.60 |

GRAY/WHITE WITH CLEAR LID

| CAT.# | H x W x D | LBS. |
|------------|------------------|------|
| 38 360 104 | 3" x 12½" x 9½" | 2.00 |
| 38 360 109 | 3" x 14½" x 18½" | 1.60 |
| 38 360 108 | 3" x 15" x 11½" | 2.20 |

GRAY/WHITE

| CAT.# | H x W x D | LBS. |
|------------|------------------|------|
| 38 360 004 | 3" x 12½" x 9½" | 2.00 |
| 38 360 009 | 3" x 14½" x 18½" | 1.60 |
| 38 360 008 | 3" x 15" x 11½" | 2.20 |
| 38 360 005 | 3" x 20½" x 16½" | 2.20 |
| 38 360 006 | 3" x 24½" x 20½" | 2.70 |

Tyvek® boxes provide superior tear and water resistance

TAN

| CAT.# | H x W x D | LBS. |
|------------|------------------|------|
| 38 350 004 | 3" x 12½" x 9½" | 2.00 |
| 38 350 009 | 3" x 14½" x 18½" | 1.60 |
| 38 350 008 | 3" x 15" x 11½" | 2.20 |

BLACK

| CAT.# | H x W x D | LBS. |
|------------|------------------|------|
| 38 370 001 | 3" x 12½" x 9½" | 2.00 |
| 38 370 002 | 3" x 14½" x 18½" | 1.60 |
| 38 370 003 | 3" x 15" x 11½" | 2.20 |
| 38 370 004 | 3" x 20½" x 16½" | 2.20 |



Corrugated Storage Carton

Accommodates letters or legal-size file folders
 • **Acid-free** heavy-duty unbuffered corrugated box; has pH of 7.2
 Ships flat and ready to assemble.

| CAT.# | H x W x D | LBS. |
|------------|-----------------|------|
| 49 540 001 | 10" x 12" x 15" | 1.28 |



No-Fold Storage Box with Lid

Double-walled box slides together in seconds, holds both letter- and legal-size documents
 • Box and lid are constructed of heavy-duty corrugated board
 Ships flat and ready to assemble. **Same Day Shipping**

| CAT.# | H x W x D | LBS. |
|------------|--------------------|------|
| 52 747 001 | 10½" x 16½" x 12½" | 1.75 |



Specifications

- Corrugated board
- Acid-free, lignin-free
- P.A.T. Certified

Storage Carton File Supports

Supports are designed to keep file folders upright in partially filled boxes
 • Supports adjust to two depths to support 1/3 or 2/3 full boxes
 • Reusable supports are shipped flat
 • Five per package

| CAT.# | DESCRIPTION | COLOR | LBS. |
|------------|-------------|--------------------|------|
| 38 013 001 | Letter-Size | B-Flute Gray-Stone | 2.30 |
| 38 013 002 | Legal-Size | White | 2.50 |

Specifications

- 3-mil copolymer of polypropylene and polyethylene
- pH-neutral
- Chemically stable



Coroplast™ Storage Carton

Clear plastic storage carton offers rigid stacking strength
 • Resists heat, repels water, and is washable Ships flat and ready to assemble.

| CAT.# | H x W x D | LBS. |
|------------|-----------------|------|
| 49 475 003 | 10" x 15" x 12" | 1.81 |



Specifications

- White corrugated board
- Acid-free, lignin-free
- 8.0-9.0 pH
- 3% calcium carbonate buffer
- P.A.T. Certified

Oversized Storage Cartons

Cartons hold up to 275 lbs. and offer superior strength for handling and stacking
 • Each carton features a shallow lid and hand cut-outs for easy transport
 Ships flat and ready to assemble. **Same Day Shipping**

| CAT.# | H x W x D | LBS. |
|------------|-----------------|------|
| 38 014 001 | 10" x 12" x 24" | 2.40 |
| 38 014 002 | 10" x 15" x 24" | 2.40 |

Archival Self-Seal Melinex® L-Sleeves

Super-clear sleeves are stable, inert, will not adhere to the surface of stored photos

- Archival-safe, high-clarity polyester sleeves are sealed on one long side and one short side
- Self-sealing flaps make it easy to insert and remove materials
- Five sleeves per pack

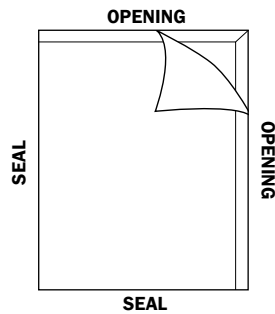

| CAT.# | THICKNESS | FITS UP TO | LBS. |
|-------------------|-----------|------------|------|
| 37 944 001 | 3-mil | 8½" x 11" | 0.40 |
| 37 944 002 | 3-mil | 9" x 12" | 0.50 |
| 37 944 003 | 3-mil | 11" x 14" | 0.50 |
| 37 944 004 | 3-mil | 12" x 17" | 0.60 |
| 37 944 005 | 3-mil | 16" x 20" | 0.70 |

Archival Melinex® L-Sleeves

L-shape makes it easy to insert and remove materials; electrostatic charge keeps contents in place

- Archival-safe Melinex® L-sleeves are high-clarity polyester sleeves that are stable, inert, and will not adhere to the surface of stored photos
- Super-clear sleeves may be sealed with double-sided tape
- 10 sleeves per pack

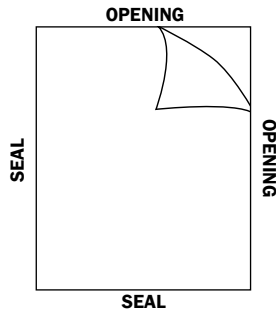

| CAT.# | THICKNESS | FITS UP TO | LBS. |
|-------------------|-----------|-------------|------|
| 37 940 003 | 3-mil | 3¾" x 6¾" | 0.20 |
| 37 940 004 | 3-mil | 4¾" x 7¾" | 0.20 |
| 37 940 006 | 3-mil | 8" x 10" | 0.40 |
| 37 940 007 | 3-mil | 8¾" x 11½" | 0.20 |
| 37 940 008 | 3-mil | 8¾" x 14½" | 0.70 |
| 37 940 009 | 3-mil | 9" x 12" | 0.50 |
| 37 940 010 | 3-mil | 9" x 14½" | 0.60 |
| 37 940 011 | 3-mil | 11" x 17" | 1.00 |
| 37 940 012 | 3-mil | 11½" x 14½" | 0.90 |
| 37 940 013 | 3-mil | 11½" x 16½" | 0.70 |
| 37 940 014 | 3-mil | 16¼" x 20½" | 1.30 |

| CAT.# | THICKNESS | FITS UP TO | LBS. |
|-------------------|-----------|-------------|------|
| 37 941 001 | 4-mil | 18" x 24" | 1.90 |
| 37 941 003 | 4-mil | 20" x 24" | 2.10 |
| 37 941 005 | 4-mil | 24" x 30" | 3.20 |
| 37 941 009 | 4-mil | 31½" x 47½" | 6.40 |

All sleeves and envelopes on this page are made of Melinex® – a high-clarity polyester film with high tensile strength and chemical stability to keep stored materials in place. Super-clear material is chemically inert, and will not discolor, cause damage to contents, or adhere to stored materials. Protects documents, photos, prints, and more from dust, dirt, and fingerprints.

Archival Melinex® Envelopes

Archival-safe, high-clarity polyester envelopes are sealed on three sides

- Short side of each envelope is open; back extends 1/2" for easy access
- Super-clear envelopes are stable, inert, and will not adhere to the surface of stored photos
- 10 envelopes per pack

| CAT.# | THICKNESS | UP TO | FITS LBS. |
|-------------------|-----------|-----------|-----------|
| 37 942 001 | 3-mil | 4" x 6" | 0.10 |
| 37 942 002 | 3-mil | 5" x 7" | 0.20 |
| 37 942 003 | 3-mil | 8½" x 11" | 0.50 |
| 37 942 004 | 3-mil | 9" x 12" | 0.70 |
| 37 942 005 | 3-mil | 11" x 14" | 0.80 |

| CAT.# | THICKNESS | UP TO | FITS LBS. |
|-------------------|-----------|-----------|-----------|
| 37 943 001 | 4-mil | 5" x 7" | 0.30 |
| 37 943 002 | 4-mil | 6" x 9" | 0.30 |
| 37 943 003 | 4-mil | 8" x 10½" | 0.60 |
| 37 943 004 | 4-mil | 8½" x 11" | 0.70 |
| 37 943 005 | 4-mil | 11" x 17" | 0.80 |

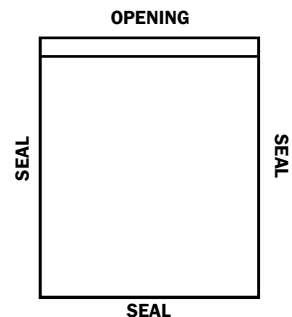

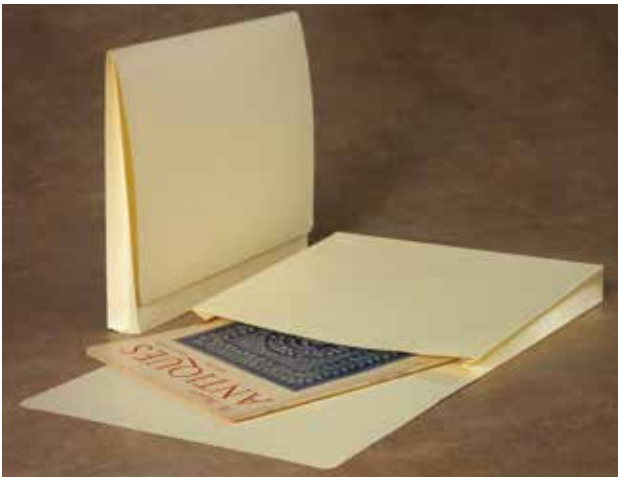

Expansion Wallets with Flap

Large overhanging flap serves to protect contents

- Pale cream-colored wallets feature pleats that are pre-scored to expand up to 1½"
- Five wallets per package

Specifications

- 10-pt. stock
- Acid-free, lignin-free
- 8.5 +/- pH
- 3% calcium carbonate buffer
- P.A.T. Certified

| CAT.# | DESCRIPTION | H x W | LBS. |
|------------|-------------|-------------|------|
| 49 362 001 | Letter | 10¼" x 12¾" | 0.80 |
| 49 362 002 | Legal | 10¼" x 14¾" | 1.00 |



Hanging File Folders

Hanging file folders include standard metal hanging rods, index tabs, and inserts

- Made of 10-pt. cream-colored stock
- 25 per package

Specifications

- 10-pt. cream stock
- Acid-free, lignin-free
- 8.5 pH
- 3% calcium carbonate buffer
- P.A.T. Certified

| CAT.# | DESCRIPTION | H x W | LBS. |
|------------|-------------|------------|------|
| 49 230 011 | Letter | 9½" x 11¾" | 3.50 |
| 49 230 014 | Legal | 9½" x 14¾" | 4.50 |



Expansion Wallets with Ribbon

Tyvek®-gusseted sides and bottom provide added strength and durability

- Cream-colored wallets have a ribbon closure

Specifications

- 20-pt. cream stock
- Acid-free, lignin-free
- Tyvek® gussets
- 3% calcium carbonate buffer
- P.A.T. Certified

| CAT.# | DESCRIPTION | H x W x GUSSET | LBS. |
|------------|-------------|------------------|------|
| 49 330 001 | Letter | 9½" x 11¾" x 3½" | 0.30 |
| 49 330 101 | Letter | 9½" x 11¾" x 5" | 0.30 |
| 49 330 002 | Legal | 9½" x 14¾" x 3½" | 0.40 |
| 49 330 102 | Legal | 9½" x 14¾" x 5" | 0.40 |



For Premium-Quality Archival-Safe Labels,
see pages 114-115.

Specifications

- 10-pt. stock
- Acid-free, lignin-free
- 8.5 +/- pH
- 3% calcium carbonate buffer
- P.A.T. Certified



Full-Cut Reinforced Tab Folders

Shrink-wrapped to preserve archival integrity

- Available in pale cream or dark tan
- Meet Library of Congress specifications
- 100 per box

PALE CREAM

| CAT.# | DESCRIPTION | H x W | TAB SIZE | LBS. |
|------------|-------------|------------------|----------|------|
| 49 228 001 | Letter | 9 7/8" x 11 3/4" | 1" | 7.00 |
| 49 224 001 | Letter | 9 7/8" x 11 3/4" | 1/2" | 7.00 |
| 49 228 002 | Legal | 9 7/8" x 14 3/4" | 1" | 7.90 |
| 49 224 002 | Legal | 9 7/8" x 14 3/4" | 1/2" | 7.90 |

DARK TAN

| CAT.# | DESCRIPTION | H x W | TAB SIZE | LBS. |
|------------|-------------|------------------|----------|-------|
| 49 225 001 | Letter | 9 7/8" x 11 3/4" | 1" | 4.38 |
| 49 225 002 | Legal | 9 7/8" x 14 3/4" | 1" | 10.46 |

Specifications

- 10-pt. stock
- Acid-free, lignin-free
- 8.5 +/- pH
- 3% calcium carbonate buffer
- P.A.T. Certified



Standard File Folders

Available in full-cut, half-cut, and third-cut tabs with rounded corners

- Shrink-wrapped to preserve archival integrity
- Meet Library of Congress specifications
- 100 per box

| CAT.# | DESCRIPTION | H x W | TAB SIZE | LBS. |
|------------|-------------|------------------|---------------|------|
| 49 231 001 | Letter | 9 1/2" x 11 3/4" | 1/2" Full-Cut | 6.10 |
| 49 231 002 | Letter | 9 1/2" x 11 3/4" | 1" Half-Cut | 6.45 |
| 49 231 003 | Letter | 9 1/2" x 11 3/4" | 1" Third-Cut | 6.45 |
| 49 231 007 | Letter | 9 1/2" x 11 3/4" | 1" Full-Cut | 6.45 |
| 49 231 004 | Legal | 9 1/2" x 14 3/4" | 1/2" Full-Cut | 8.50 |
| 49 231 005 | Legal | 9 1/2" x 14 3/4" | 1" Half-Cut | 7.70 |
| 49 231 006 | Legal | 9 1/2" x 14 3/4" | 1" Third-Cut | 7.80 |
| 49 231 008 | Legal | 9 1/2" x 14 3/4" | 1" Full-Cut | 7.80 |

Specifications

- 10-pt. stock
- Acid-free, lignin-free
- 8.5 +/- pH
- 3% calcium carbonate buffer
- P.A.T. Certified



Oversized File Folders

Safely protect larger material

- Protect and store oversized prints, documents, and photographs
- 10 per package

| CAT.# | H x W | LBS. |
|------------|-----------|------|
| 38 436 001 | 11" x 17" | 1.20 |
| 38 436 002 | 16" x 20" | 1.40 |

Specifications

- 20-pt. cream stock
- Acid-free, lignin-free
- 8.5 pH
- 3% calcium carbonate buffer
- P.A.T. Certified



Heavyweight File Folders

Twice the thickness of regular file folders

- Both letter- and legal-size folders feature non-reinforced, full-cut tabs for easy identification
- Meet Library of Congress specifications
- 25 per package

| CAT.# | DESCRIPTION | H x W | LBS. |
|------------|-------------|------------------|------|
| 49 312 001 | Letter | 9 7/8" x 11 3/4" | 3.00 |
| 49 312 002 | Legal | 9 7/8" x 14 3/4" | 4.00 |

Specifications

- 10-pt. stock
- Acid-free, lignin-free
- 8.5 +/- pH
- 3% calcium carbonate buffer
- P.A.T. Certified



Pleated File Jackets

Sturdy jackets feature 1" pleat for expansion, 1" extended reinforced tab for labeling

- Meet Library of Congress specifications
- 10 per package

| CAT.# | DESCRIPTION | H x W | LBS. |
|------------|-------------|---------------|------|
| 49 363 001 | Letter | 10" x 11 3/4" | 0.60 |
| 49 363 002 | Legal | 10" x 14 3/4" | 0.70 |

Specifications

- 10- or 20-pt. tan folder stock
- Acid-free, lignin-free
- 8.5 pH
- 3% calcium carbonate buffer



Map and Print Folders

Oversize folders are ideal for protecting maps and large prints inside flat files or **acid-free** boxes

- Folders are straight cut and flush folded
- 10 folders per pack

Same Day Shipping

10-PT.

| CAT.# | H x W | LBS. |
|------------|-----------|-------|
| 38 346 101 | 18" x 24" | 3.30 |
| 38 346 102 | 20" x 24" | 3.53 |
| 38 346 103 | 20" x 30" | 4.60 |
| 38 346 104 | 24" x 36" | 8.00 |
| 38 346 105 | 30" x 42" | 11.00 |
| 38 346 106 | 36" x 48" | 14.00 |

20-PT. (HEAVY-WEIGHT)

| CAT.# | H x W | LBS. |
|------------|-----------|-------|
| 38 347 103 | 36" x 48" | 12.50 |



Polyester Rolls

Acid-free archival grade polyester (Mylar) is chemically inert and will not discolor or cause damage with age

- Polyester is a versatile product that can be used for encapsulation, book protection, interleaving, wrapping, and lining shelves
- Choose from a variety of mil thicknesses and film clarities

Same Day Shipping/SafePack

LO-LUSTER 1.5-MIL

| CAT.# | SIZE | LBS. |
|------------|------------|------|
| 10 612 001 | 12" x 300' | 4.00 |
| 10 614 001 | 14" x 300' | 4.80 |
| 10 616 001 | 16" x 300' | 5.40 |
| 10 617 001 | 24" x 300' | 7.03 |

CLEAR 2-MIL

| CAT.# | SIZE | LBS. |
|------------|------------|------|
| 10 120 112 | 12" x 150' | 4.10 |
| 10 120 116 | 16" x 150' | 2.80 |
| 10 120 120 | 20" x 150' | 3.20 |
| 10 120 010 | 10" x 300' | 3.70 |
| 10 120 012 | 12" x 300' | 4.20 |
| 10 120 014 | 14" x 300' | 5.10 |
| 10 120 020 | 20" x 300' | 6.40 |

CLEAR 3- AND 5-MIL*

| CAT.# | SIZE | THICKNESS | LBS. |
|------------|-----------|-----------|------|
| 55 179 003 | 40" x 50' | 3-mil | 6.60 |
| 55 179 005 | 40" x 50' | 5-mil | 9.00 |

*Oversized rolls ship in cartons.

SUPER CLEAR 1.5-MIL

| CAT.# | SIZE | LBS. |
|------------|------------|------|
| 10 115 012 | 12" x 300' | 4.00 |
| 10 115 014 | 14" x 300' | 4.80 |
| 10 115 016 | 16" x 300' | 5.40 |
| 10 115 020 | 20" x 300' | 6.20 |

SUPER CLEAR 4-MIL

| CAT.# | SIZE | LBS. |
|------------|-----------|------|
| 55 178 009 | 9" x 50' | 2.97 |
| 55 178 010 | 10" x 50' | 3.26 |
| 55 178 012 | 12" x 50' | 3.48 |
| 55 178 014 | 14" x 50' | 4.25 |
| 55 178 020 | 20" x 50' | 5.24 |

Archival Polyester Encapsulation Sheets

Acid-free archival grade super clear 2-mil polyester (Mylar) sheets

- Chemically inert
- Use with Scotch® 415 tape (sold below) to encapsulate documents or photos



| CAT.# | INTERIOR H x W | LBS. |
|------------|----------------|------|
| 10 390 001 | 8½" x 11" | 0.75 |
| 10 390 002 | 10" x 12" | 1.00 |
| 10 390 003 | 12" x 14" | 1.40 |
| 10 390 004 | 18¾" x 26" | 4.10 |

Scotch® Double-Coated Clear 415 Tape

Use for encapsulating or mounting photos

- Double-coated tapes feature high-tack acrylic adhesive and 60-lb. high-density paper liner
- Won't dry out, crack, or yellow with age
- All rolls on 3" core



| CAT.# | W x L | LBS. |
|------------|----------------|------|
| 32 415 001 | 1/4" x 36 yds. | 0.10 |
| 32 415 002 | 1/2" x 36 yds. | 0.20 |
| 32 415 004 | 1" x 36 yds. | 0.50 |

For Bone Folders, see page 94.



Specifications

- 10- and 7-pt. buffered folder stock
- Acid-free, lignin-free
- pH-neutral adhesive
- P.A.T. Certified

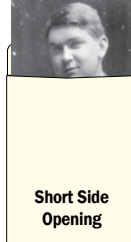

Archival-Safe PolyEnvelopes

PVC-free polypropylene envelopes are chemically stable and feature a Velcro® closure

- Resist moisture, staining, and tears
- #49 612 002 has three holes to fit any three-ring binder; #49 612 003 features a clear business card-size pocket
- **P.A.T. Certified**
(0.15 lb.)

Storage Envelopes

Envelopes can be used to protect prints, ephemera, and more

- Envelopes feature pH-neutral adhesive to attach seams and ungummed flaps
- Long side opening envelopes are 10-pt. pale cream stock and 25 per package
- Short side opening envelopes are 7-pt. white stock and 100 per package

| CAT.# | OPENING | H x W | LBS. |
|------------|------------|-------------|------|
| 49 235 001 | Long Side | 9½" x 11¾" | 2.00 |
| 49 235 002 | Long Side | 9½" x 14¾" | 2.50 |
| 49 235 003 | Long Side | 11½" x 14¾" | 2.80 |
| 49 236 001 | Short Side | 6" x 9" | 2.70 |
| 49 236 003 | Short Side | 7" x 10" | 3.70 |
| 49 236 005 | Short Side | 8½" x 11½" | 4.60 |
| 49 236 006 | Short Side | 9" x 12" | 5.60 |
| 49 236 007 | Short Side | 10" x 13" | 6.30 |
| 49 236 008 | Short Side | 11½" x 15½" | 8.40 |

| CAT.# | DESCRIPTION | H x W |
|------------|-------------------------------|------------|
| 49 612 001 | Letter-Side Loading | 13" x 9½" |
| 49 612 002 | Letter-Side Loading w/ Holes | 11½" x 9¾" |
| 49 612 003 | Letter Side Loading w/ Pocket | 11¾" x 9" |



Four-Flap Enclosures

Scores prevent appearance of stress points and flap lines on stored contents

- Four-flap design encloses and protects documents, ephemera, and prints during handling and storage
- Five enclosures per package

Specifications

- 10-pt. scored folder stock
- Acid-free, lignin-free
- 3% calcium carbonate buffer
- P.A.T. Certified

| CAT.# | WORKING DEPTH | H x W | LBS. |
|------------|---------------|------------|------|
| 38 479 001 | 1/4" | 8" x 6" | 0.60 |
| 38 479 002 | 1/4" | 9½" x 6½" | 0.80 |
| 38 479 005 | 1/4" and 1/2" | 11¾" x 9" | 1.80 |
| 38 479 006 | 1/4" and 1/2" | 15¾" x 9" | 2.00 |
| 38 479 007 | 1/4" and 1/2" | 13¾" x 10" | 2.50 |
| 38 479 008 | 1/4" and 1/2" | 14¾" x 11" | 3.00 |

Envelope Slings

Light-cream slings protect fragile or brittle documents

- Sized to fit top-opening envelopes (sold separately)
- 10 slings per package

Same Day Shipping

Specifications

- 7-pt. buffered stock
- Acid-free, lignin-free
- 8.5 pH

| CAT.# | SLING SIZE | FITS ENVELOPE SIZE | LBS. |
|------------|------------|--------------------|------|
| 49 229 002 | 6¾" x 9¾" | 7" x 10" | 0.20 |
| 49 229 003 | 8¾" x 10¾" | 8½" x 11½" | 0.40 |
| 49 229 004 | 8¾" x 11¾" | 9" x 12" | 0.40 |
| 49 229 005 | 9¾" x 12¾" | 10" x 13" | 0.50 |



Large Storage Bags

2-mil polyethylene bags protect prints, ephemera, and other materials against fingerprints, dust, and moisture

- 100 archival-quality bags per package
- P.A.T. Certified

| CAT.# | SIZE | LBS. |
|------------|-----------|------|
| 38 559 001 | 8" x 10" | 1.20 |
| 38 559 002 | 11" x 14" | 1.20 |
| 38 559 003 | 14" x 18" | 1.50 |
| 38 559 004 | 16" x 20" | 2.00 |
| 38 559 005 | 20" x 24" | 2.50 |



Slide-Rite Storage Bags

Easy to open and handle while wearing gloves

- 2.7-mil archival-quality bags are equipped with a secure sliding plastic seal to protect valuables
- 50 bags per package

| CAT.# | SIZE | LBS. |
|------------|-----------|------|
| 38 589 001 | 8" x 7" | 1.00 |
| 38 589 003 | 14" x 11" | 2.00 |
| 38 589 004 | 9" x 12" | 1.80 |
| 38 589 005 | 16" x 12" | 2.50 |



Zip-Lock Storage Bags

Soft 2-mil uncoated archival-quality bags feature a zip-lock seal to protect contents from dust and moisture

- 100 bags per package

| CAT.# | SIZE | LBS. |
|------------|----------|------|
| 38 689 005 | 2" x 3" | 0.50 |
| 38 689 001 | 6" x 4" | 0.50 |
| 38 689 002 | 7" x 5" | 1.00 |
| 38 689 003 | 8" x 6" | 1.20 |
| 38 689 004 | 12" x 9" | 2.10 |

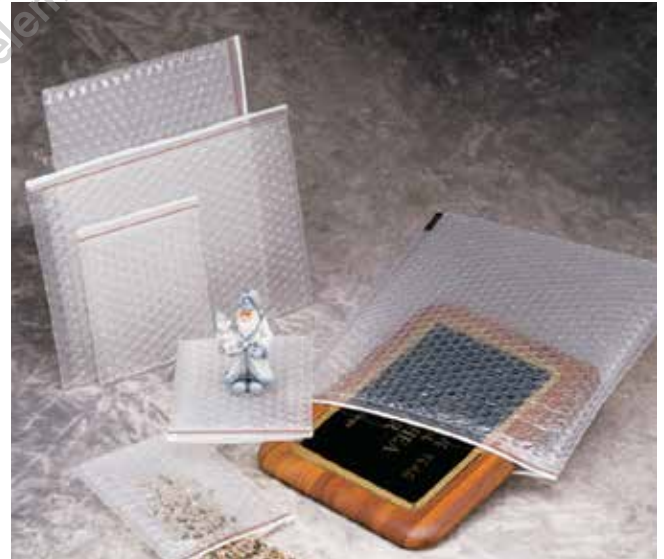

Padded Storage Bags

Double-track zippered seal adds extra security; can be opened easily while wearing gloves

- Polypropylene bags with bubble enclosures protect valuables during storage or transport
- 10 archival-quality bags per package

| CAT.# | SIZE | LBS. |
|------------|-----------|------|
| 38 489 013 | 8" x 10" | 0.50 |
| 38 489 014 | 8" x 12" | 0.50 |
| 38 489 016 | 12" x 12" | 0.50 |

Art Profolio® PolyZip™ Art & Photo Envelopes

Acid-free, lignin-free, archival-safe 20-mil polypropylene envelopes provide storage for valuable artwork and photography

- Easy-to-use zip closure seals out dust and moisture
- Expanding 1¼" gusset provides flexible storage; clear front pocket offers space for indexing, page insertion, or content sample



| CAT.# | SIZE | LBS. |
|------------|-----------|------|
| 49 813 001 | 4" x 6" | 0.06 |
| 49 813 002 | 5" x 7" | 0.06 |
| 49 813 003 | 8" x 10" | 0.12 |
| 49 813 004 | 8½" x 11" | 0.12 |
| 49 813 005 | 9" x 12" | 0.12 |
| 49 813 006 | 11" x 14" | 0.19 |
| 49 813 007 | 11" x 17" | 0.19 |
| 49 813 008 | 13" x 19" | 0.31 |
| 49 813 009 | 14" x 17" | 0.31 |

One-Piece Pamphlet Binders

Built-in single- or double-stitched binder tape for long life

- Binder Covers: Choose 8.0-9.0 pH, **acid-free**, lignin-free 60-pt. archival-quality Barrier Board; also available in polypropylene front with 60-pt. Barrier Board back
- Spine Tape: Grade C Book Cloth permanently attaches and joins covers
- Binder Tape: Gray cambric cloth gummed on one side with **acid-free** adhesive; stitching sewn with cotton thread
- Adhesive: 8.5 pH, water-based, PVA (polyvinyl acetate)
- **Minimum order is 25 binders per size and stitching**

Custom crafted.

All binders have radius edges; specify square edges if desired.



ARCHIVAL-QUALITY SINGLE-STITCHED CLEAR POLYPROPYLENE FRONT WITH GRAY BOARD BACK BINDERS

| CAT.# | H x W |
|------------|------------|
| 52 603 001 | 7" x 5" |
| 52 603 002 | 9" x 6" |
| 52 603 003 | 9½" x 6¾" |
| 52 603 004 | 9" x 7" |
| 52 603 005 | 10" x 7" |
| 52 603 006 | 10½" x 7¾" |
| 52 603 007 | 11" x 8" |
| 52 603 008 | 11" x 8½" |
| 52 603 009 | 12" x 9" |
| 52 603 010 | 12" x 10" |
| 52 603 011 | 13" x 10" |
| 52 603 012 | 14" x 11" |

Specify width between stitches when ordering.



Single-stitched: Holds up to 3/8" thickness.



Double-stitched: Holds from 1/4" - 2" thickness. (Specify width between stitches - 1/4", 1/2", 3/4", 1", 1½", 1¾", 1¾", or 2")

ARCHIVAL-QUALITY SINGLE-STITCHED 60-PT. GRAY BOARD BINDERS

| CAT.# | H x W |
|------------|------------|
| 52 604 001 | 7" x 5" |
| 52 604 002 | 9" x 6" |
| 52 604 003 | 9½" x 6¾" |
| 52 604 004 | 9" x 7" |
| 52 604 005 | 10" x 7" |
| 52 604 006 | 10½" x 7¾" |
| 52 604 007 | 11" x 8" |
| 52 604 008 | 11" x 8½" |
| 52 604 009 | 12" x 9" |
| 52 604 010 | 12" x 10" |
| 52 604 011 | 13" x 10" |
| 52 604 012 | 14" x 11" |

ARCHIVAL-QUALITY DOUBLE-STITCHED 60-PT. GRAY BOARD BINDERS

| CAT.# | H x W |
|------------|------------|
| 52 605 001 | 7" x 5" |
| 52 605 002 | 9" x 6" |
| 52 605 003 | 9½" x 6¾" |
| 52 605 004 | 9" x 7" |
| 52 605 005 | 10" x 7" |
| 52 605 006 | 10½" x 7¾" |
| 52 605 007 | 11" x 8" |
| 52 605 008 | 11" x 8½" |
| 52 605 009 | 12" x 9" |
| 52 605 010 | 12" x 10" |
| 52 605 011 | 13" x 10" |
| 52 605 012 | 14" x 11" |

Brodart One-Piece Pamphlet Binders are available with built-in 3M™ Security Strips and are designed to work with your 3M™ electromagnetic detection system. Call for pricing and details.



Flip-Top Pamphlet File Box

Heavy-duty corrugated board is acrylic-coated to repel moisture and fingerprints

- Easy-open flip-top with hinged lid offers added protection and easy access to contents
- File box ships flat and ready to assemble

Specifications

- B-flute gray stone corrugated board
- Acrylic coated
- Acid-free, lignin-free
- 8.0-9.0 pH
- 3% calcium carbonate buffer
- P.A.T. Certified

| CAT.# | H x W x D | LBS. |
|------------|-----------------|------|
| 49 185 001 | 12" x 10½" x 5" | 0.20 |

For Archival Tissue, see page 28.



Ledger Book Box

Two-piece box holds heavy ledger books up to 5" thick

- Exposed serrated edge to reduce chance of injury
- Shrink-wrapped with polyethylene to preserve archival integrity
- Deep telescoping lid protects contents from dust and dirt
- Boxes are safe for long-term storage and feature metal-reinforced edges for stacking strength and durability

Specifications

- 60-pt. gray/white barrier board
- Acid-free, lignin-free
- 8.0-9.0 pH
- 3% calcium carbonate buffer
- P.A.T. Certified

| CAT.# | H x W x D | LBS. |
|------------|----------------|------|
| 38 398 001 | 5" x 12" x 12" | 2.50 |

Specifications

- 60-pt. gray/white or black barrier board
- Acid-free, lignin-free
- 8.0-9.0 pH
- 3% calcium carbonate buffer
- P.A.T. Certified



Clamshell Drop Spine Boxes

One-piece clamshell-style storage boxes can hold individual books, digital prints, or artifacts

- Exposed serrated edge to reduce chance of injury
- Shrink-wrapped with polyethylene to preserve archival integrity
- With drop spines, boxes lie flat for convenient access
- Safe for long-term storage
- All boxes feature metal-reinforced edges for stacking strength and durability



BLACK

| CAT.# | H x W x D | LBS. |
|------------|-------------------|------|
| 38 379 001 | 3" x 12¼" x 9" | 0.84 |
| 38 379 002 | 3" x 15¼" x 10¼" | 1.00 |
| 38 379 003 | 3¼" x 17¼" x 11½" | 1.37 |

GRAY/WHITE

| CAT.# | H x W x D | LBS. |
|------------|-------------------|------|
| 38 298 001 | 1½" x 6½" x 9½" | 1.50 |
| 38 298 002 | 2½" x 6½" x 9½" | 1.80 |
| 38 298 003 | 3½" x 6½" x 9½" | 2.00 |
| 38 298 004 | 1½" x 7½" x 10½" | 1.50 |
| 38 298 005 | 2½" x 7½" x 10½" | 1.80 |
| 38 298 006 | 3½" x 7½" x 10½" | 2.00 |
| 38 359 001 | 3" x 12¼" x 9" | 0.60 |
| 38 359 002 | 3" x 15¼" x 10¼" | 1.00 |
| 38 359 003 | 3¼" x 17¼" x 11½" | 1.00 |



Flip-Top Pamphlet Boxes

Metal-reinforced edges for stacking strength and durability

- Exposed serrated edge to reduce chance of injury
- Shrink-wrapped with polyethylene to preserve archival integrity
- Easy-open hinged lid protects pamphlets, catalogs, manuals, and other documents from dust, dirt, and airborne pollution
- Boxes are safe for long-term storage

Specifications

- 60-pt. gray/white barrier board
- Acid-free, lignin-free
- 8.0-9.0 pH
- 3% calcium carbonate buffer
- P. A.T. Certified

| CAT.# | H x W x D | LBS. |
|------------|-----------------|------|
| 49 507 001 | 10" x 7" x 4" | 2.50 |
| 49 505 001 | 11½" x 9" x 4½" | 3.00 |



Curved-Top Pamphlet Files

Open-top design offers instant access to pamphlets, periodicals, music scores, and other items

- Exposed serrated edge to reduce chance of injury
- Shrink-wrapped with polyethylene to preserve archival integrity
- Metal-reinforced edges for strength and durability

Specifications

- 60-pt. gray/white or tan
- Acid-free, lignin-free
- 8.0-9.0 pH
- 3% calcium carbonate buffer
- P. A.T. Certified

GRAY/WHITE

| CAT.# | H x W x D | LBS. |
|------------|-----------------|------|
| 49 503 001 | 9" x 3" x 6" | 2.00 |
| 49 504 001 | 9" x 3" x 8" | 3.00 |
| 49 502 001 | 11" x 3½" x 10" | 1.00 |

TAN

| CAT.# | H x W x D | LBS. |
|------------|-----------------|------|
| 49 502 002 | 11" x 3½" x 10" | 1.50 |



Curved-Top Corrugated Pamphlet Files

Open-top design offers instant access to pamphlets, magazines, and other items

- Five files per package
- Files ship flat and ready to assemble (1.75 lbs.) **Same Day Shipping**

Specifications

- B-flute gray stone corrugated board
- Acid-free, lignin-free
- 8.0-9.0 pH
- 3% calcium carbonate buffer
- P. A.T. Certified

| CAT.# | H x W x D |
|------------|-----------------|
| 49 547 001 | 11½" x 4" x 9" |
| 49 547 002 | 11" x 3½" x 10" |



Pamphlet File with Case

Safe long-term storage for pamphlets and other materials

- Exposed serrated edge to reduce chance of injury
- Shrink-wrapped with polyethylene to preserve archival integrity
- Case provides added protection for both contents and file box
- Both file and case have metal-reinforced edges for extra stacking strength and durability

Specifications

- 60-pt. gray/white barrier board
- Acid-free, lignin-free
- 8.0-9.0 pH
- 3% calcium carbonate buffer
- P. A.T. Certified

Same Day Shipping/SafePack

| CAT.# | H x W x D | LBS. |
|------------|-----------------|------|
| 49 460 001 | 11" x 3½" x 10" | 1.15 |



Buffered Tissue

Thin, flexible tissue is **acid-free**, lignin-free, and chlorine-free

- Buffered with approximately 2.8% calcium carbonate
- pH of 9.0-10.0
- 100 sheets per package

| CAT.# | SIZE | LBS. |
|-------------------|-----------|------|
| 38 275 001 | 20" x 30" | 2.29 |

Unbuffered Tissue

Soft, ultra-thin **acid-free** tissue is ideal for use with photographs or textiles made with animal fibers

- 100 sheets per package

| CAT.# | SIZE | LBS. |
|-------------------|-----------|------|
| 38 275 002 | 20" x 30" | 2.01 |

(A) 10-Pt. Folder Stock

Light cream folder stock is **acid-free** and lignin-free

- pH of 8.5; 3% calcium carbonate buffer
- Meets Library of Congress Specifications
- **P.A.T. Certified.**
- 25 sheets per package

Same Day Shipping: except 32"H x 40"W ship from manufacturer.

| CAT.# | H x W | LBS. |
|-------------------|-----------|-------|
| 42 343 001 | 16" x 20" | 4.00 |
| 42 343 002 | 18" x 24" | 7.00 |
| 42 343 003 | 32" x 40" | 12.00 |

(B) 60-Pt. Barrier Board

Barrier board is used to construct boxes, dividers, mats, pamphlet covers, and more

- Long grain 60-pt. gray/white barrier board is **acid-free** and lignin-free
- pH of 8.0-9.0; 3% calcium carbonate buffer
- **P.A.T. Certified**
- 25 sheets per package

| CAT.# | H x W | LBS. |
|-------------------|-----------|-------|
| 42 342 001 | 16" x 20" | 36.00 |

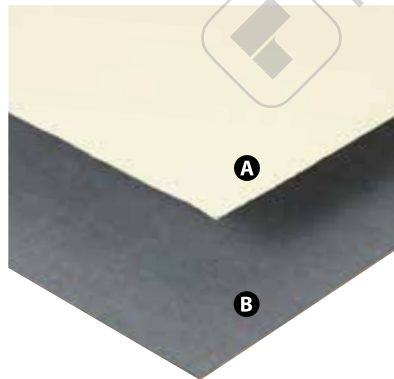

Permalife Bond Paper

Has a life expectancy of 300 years when stored properly

- Archival-quality; **P.A.T. Certified**
- Manufactured from **acid-free**, lignin-free buffered material
- Preservation quality paper is watermarked for identification
- Will not yellow or discolor

| CAT.# | H x W | SHEETS PER PACK | LBS. |
|-------------------|--------------------|-----------------|-------|
| 38 395 001 | 8½" x 11" | 500 | 2.00 |
| 38 395 002 | 8½" x 14" | 500 | 2.50 |
| 38 395 003 | 11" x 17" | 500 | 3.00 |
| 38 395 101 | 34" x 100 yd. Roll | — | 15.60 |

Acid-Free Tissue

Soft, thin white tissue is perfect for interleaving, wrapping, and cushioning

- Tissue buffered with 3% calcium carbonate and pH of 8.5; helps prevent acid migration and color transfer
- Both buffered and unbuffered (7.0 pH) tissue protect against scuffing or breakage during storage and handling
- **P.A.T. Certified**
- 100 sheets per package



BUFFERED

| CAT.# | DESCRIPTION | LBS. |
|-------------------|-------------------|-------|
| 38 018 001 | 10" x 15" Sheets | 0.90 |
| 38 018 002 | 15" x 20" Sheets | 1.50 |
| 38 018 003 | 30" x 40" Sheets | 4.40 |
| 39 003 001 | 40" x 1,000' Roll | 10.50 |

UNBUFFERED

| CAT.# | DESCRIPTION | LBS. |
|-------------------|------------------|------|
| 38 211 001 | 10" x 15" Sheets | 0.90 |
| 38 211 002 | 15" x 20" Sheets | 1.50 |
| 39 501 001 | 30" x 250' Roll | 3.60 |
| 39 501 002 | 30" x 500' Roll | 5.80 |

Glassine Paper

Smooth-textured paper folds easily to create enclosures

- 1-mil, unbuffered, **acid-free**, translucent paper
- pH of 7.0; ideal for interleaving
- 100 sheets per package



| CAT.# | H x W | LBS. |
|-------------------|-------------------|-------|
| 42 138 001 | 11" x 14" Sheets | 4.20 |
| 42 138 002 | 14" x 18" Sheets | 4.70 |
| 42 138 003 | 16" x 20" Sheets | 5.10 |
| 42 138 004 | 48" x 1,000' Roll | 34.00 |



Exact-Fit Rare Book Boxes

Boxes offer ideal storage for thick pamphlets, softcover books, and fragile or damaged books

- Measure the height and width of your book and select the appropriate size from the table below
- Easy to assemble
- Two boxes (four boards) per package; includes Velcro® attaching buttons

Specifications

- 20-pt. light tan folder stock
- Acid-free, lignin-free
- 3% calcium carbonate buffer
- P. A.T. Certified

| CAT.# | H x W | LBS. |
|------------|-----------|------|
| 38 525 001 | 6" x 23" | 0.30 |
| 38 525 002 | 7" x 17" | 0.30 |
| 38 525 003 | 7" x 25" | 0.40 |
| 38 525 004 | 8" x 19" | 0.50 |
| 38 525 005 | 8" x 27" | 0.70 |
| 38 525 006 | 9" x 21" | 0.70 |
| 38 525 007 | 9" x 29" | 0.90 |
| 38 525 008 | 10" x 23" | 1.00 |
| 38 525 009 | 10" x 31" | 1.00 |
| 38 525 010 | 11" x 25" | 1.00 |
| 38 525 011 | 11" x 33" | 1.00 |
| 38 525 012 | 12" x 27" | 1.00 |
| 38 525 013 | 12" x 35" | 1.20 |
| 38 525 014 | 14" x 31" | 1.20 |
| 38 525 015 | 14" x 37" | 1.40 |



Book Totes

Totes include an insert for partially filled trays

- Gray stone corrugated totes feature an acrylic coating to repel moisture
- Ships flat and ready to assemble

Specifications

- B-flute gray stone corrugated board
- Acid-free, lignin-free
- Acrylic coated
- 8.0-9.0 pH
- 3% calcium carbonate buffer
- P. A.T. Certified

| CAT.# | H x W x D | LBS. |
|------------|---------------|------|
| 49 395 001 | 6" x 17" x 6" | 1.50 |
| 49 395 002 | 6" x 17" x 7" | 1.80 |
| 49 395 003 | 6" x 17" x 8" | 2.00 |

Rare Book Identia-Strips

10-pt. acid-free, lignin-free die-cut pale cream strips

- Available with or without tabs
- Tabbed strips feature a cut 1" from top to mark the page
- Non-tabbed strips are ideal for books with brittle pages
- 100 strips per package

Same Day Shipping



| CAT.# | DESCRIPTION | H x W | LBS. |
|------------|-------------|--------------|------|
| 38 451 001 | Tabbed | 5" x 2 1/4" | 0.40 |
| 38 451 002 | Tabbed | 10" x 2 1/4" | 0.80 |
| 38 451 003 | Non-Tabbed | 10" x 2 1/4" | 0.70 |

Tying Tape

Available in 5/16" or 5/8" widths in rolls of 100, 500, or 1,000 yards

- 100% unbleached cotton tape is soft, non-abrasive, free of dye, and reusable
- Tape holds damaged book together until repairs can be made
- Tape can also be used to tie textiles

| CAT.# | W x L | LBS. |
|------------|--------------------|------|
| 42 096 001 | 5/16" x 100 yds. | 1.20 |
| 42 096 002 | 5/16" x 1,000 yds. | 2.50 |
| 42 096 004 | 5/8" x 500 yds. | 2.30 |
| 42 096 003 | 5/8" x 1,000 yds. | 4.60 |



Disposable White Cotton Gloves

Acid-free bleached cotton lisle gloves feature reversible design that fits right or left hand

- Form-fitting and lightweight
- 12 pairs per package (0.10 lb.)



| CAT.# | DESCRIPTION |
|------------|-------------|
| 55 635 001 | Women's |
| 55 636 001 | Men's |

Sure Grip Cotton Gloves

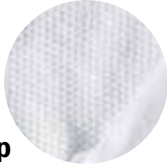

Non-slip nodules cover the entire surface for a secure grip

- 100% cotton gloves are washable for repeated use
- Not for use with metal artifacts
- 12 pairs per package

| CAT.# | DESCRIPTION | LBS. |
|------------|-------------|------|
| 55 416 001 | Small | 1.00 |
| 55 416 002 | Medium | 1.00 |
| 55 416 003 | Large | 1.00 |

ESD Nylon Gloves

Acid-free polygenex nylon gloves dissipate static

- Comfortable to wear all day
- Washable for repeated use
- 12 pairs per package

Same Day Shipping



| CAT.# | DESCRIPTION | LBS. |
|------------|-------------|------|
| 55 085 001 | Small | 1.00 |
| 55 085 002 | Large | 1.00 |

Mini Digital Humidity and Temperature Meter

Meter can be hung or used freestanding and is small enough to use in museum display cases

- Device has an LCD display that measures 1.4"H x 0.7"W and memory for highest temperature, lowest temperature, and humidity readings
- Records temperature ranges from 14°-140° F with +/- 1.8° accuracy and humidity ranges from 10-99% RH with +/- 5% accuracy
- Includes one LR44 battery

Note: Displays temperature in Fahrenheit only.

Same Day Shipping



| CAT.# | H x W x D | LBS. |
|------------|-----------------|------|
| 40 407 001 | 1½" x 2" x 3/5" | 0.20 |

UV Fluorescent Light Filters

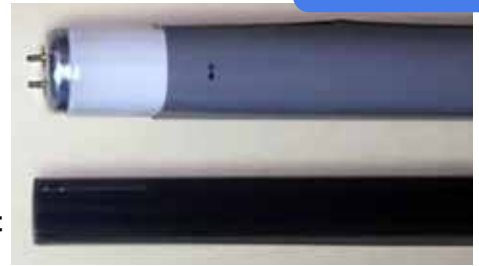

Filter out 98% of harmful ultraviolet light

- Archival-quality smoke-colored polyester sheets protect books, papers, fabrics, artwork, and photos
- Easy snap-on design fits over any-size tube
- 48" sheet size fits T-12 tubes (can be cut in half to fit 24" tubes)
- 96" tubes will require two sheets
- Ten 48" sheets per package

| CAT.# | LBS. |
|------------|------|
| 55 185 001 | 2.00 |



Bookkeeper Deacidification Spray

Neutralizes harmful acids; virtually odor-free; dries in minutes

- Will not discolor or damage inks or colors
- Non-toxic, non-flammable; contains no CFCs
- 5.29 oz. refillable spray bottle treats over 25 square feet of paper

Same Day Shipping

| CAT.# | SIZE | LBS. |
|------------|--|------|
| 38 460 003 | 5.29 oz. Pump Spray | 0.50 |
| 38 460 002 | 900 grams/20 Fluid oz. Refill for Pump Spray | 2.60 |

pH Testing Pen

Easily determines the acidic or alkaline properties of paper and board

- Purple color denotes a pH level of 6.5 or higher
- Testing may be less reliable on coated or colored paper

Same Day Shipping



| CAT.# | LBS. |
|------------|------|
| 55 077 001 | 0.02 |



Micron Pens and Pen Sets

Will not smear, feather, or bleed through on most papers

- Archival-quality Pigma® ink meets ASTM and ACMI non-toxicity standards for use in acid-free environments
- All inks are chemically stable, quick-drying, waterproof, and fade-resistant
- Resists discoloring and will not clog or dry out
- 6-Pack Set with black ink includes pt. sizes 005, 01, 02, 03, 05, and 08
- 6-Pack Set/Assorted Colors includes red, blue, green, brown, purple, and black

Same Day Shipping

| CAT.# | DESCRIPTION | PT. SIZE | LBS. |
|------------|------------------------|----------|------|
| 55 075 002 | Single Pen/Black Ink | 05 | 0.10 |
| 55 075 003 | Single Pen/Black Ink | 08 | 0.10 |
| 36 569 001 | 6-Pack/Black Ink | Assorted | 0.30 |
| 36 571 001 | 6-Pack/Assorted Colors | 05 | 0.30 |

For Scotch® Double-Coated Clear 415 Tape, see page 22.



Archival Photo Mounting Corners

Will not damage photos or paper and require no messy glue, mounting adhesive, or tape

- 1/2" polyester corners feature **acid-free**, non-yellowing pressure-sensitive adhesive backing
- 240 corners per package
- **P.A.T. Certified**

| CAT.# | LBS. |
|------------|------|
| 38 120 001 | 0.10 |

Gold, Silver, and White Markers



These permanent ink markers are ideal for videocassettes, decorating, or illustrating

- Work well with paper, vinyl, plastic, photos, and leather
- White marker features a fine-point nib and quick-drying opaque ink

Same Day Shipping

| CAT.# | COLOR | POINT | LBS. |
|------------|--------|------------|------|
| 75 124 001 | Gold | Medium | 0.80 |
| 75 124 002 | Silver | Medium | 0.72 |
| 75 124 003 | Gold | Extra Fine | 0.64 |
| 55 066 001 | White | Fine | 0.48 |

Scotch® Double-Sided Scrapbooking Tape

Perfect for mending and repairing pictures, documents, and memorabilia

- Mending tape for photos and documents is totally **acid-free**
- Double-sided tape is independently laboratory-tested and guaranteed safe for use on photos
- Made in the USA
- **P.A.T. Certified**

Same Day Shipping



| CAT.# | SIZE | LBS. |
|------------|-------------|------|
| 55 319 002 | 1/2" x 300" | 0.09 |



PEC Pad® Photo Wipes

Soft, lint-free, non-abrasive 4" x 4" pads

- Can be safely used to clean sensitive surfaces such as photos, negatives, slides, scanners, CDs, mirrors, lenses, telescopes, and inkjet print heads
- Can be used with PEC-12 photographic emulsion cleaner



| CAT.# | QUANTITY | LBS. |
|------------|-----------|------|
| 38 198 002 | 100 Wipes | 0.50 |



Three-Ring Binder Pages

Crystal-clear print protection

- 2-mil clear polyester cover
- 10-pt. cream mounting paper pages
- **P.A.T. Certified**, acid-free, and lignin-free
- 50 pages and protectors per package

| CAT.# | H x W | LBS. |
|-------------------|-------------------------|------|
| 38 214 001 | 11" x 8 $\frac{1}{2}$ " | 2.50 |



Topper Sheet Protectors

Protect key documents

- Heavyweight clear polypropylene sheet protectors are pre-punched for three-ring binders
- Top-loading sheets are sealed on three sides with reinforced binding edge
- **P.A.T. Certified**
- 50 per box

| CAT.# | LBS. |
|-------------------|------|
| 13 162 001 | 1.50 |



SafeCare® Album and Slipcase

110-pt. stock album and slipcase covered in black buckram fabric

- **Acid-free**, pH-neutral
- 2 $\frac{1}{2}$ " spine features three 1 $\frac{1}{2}$ " D rings that accommodate up to 50 pages sized up to 9 $\frac{1}{2}$ " x 12"

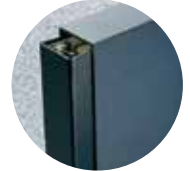

| CAT.# | H x W | LBS. |
|-------------------|--------------------------|------|
| 38 680 001 | 12" x 11 $\frac{3}{4}$ " | 3.00 |



Three-Ring Binder Archival Page Protectors

Crystal-clear 4-mil polyester protectors

- Sealed on three sides with one open long side
- Designed to fit any standard three-ring binder album
- **P.A.T. Certified**.
- 25 protectors per package

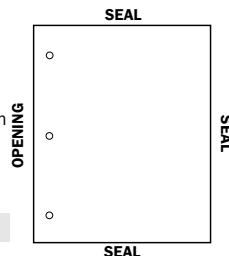

| CAT.# | H x W | LBS. |
|-------------------|--|------|
| 38 213 001 | 11 $\frac{1}{4}$ " x 8 $\frac{1}{2}$ " | 0.50 |



Oversized Three-Ring Binder Pages

Provide archival-safe storage of prints or documents

- Lightweight 3-mil polyester protectors and 70-lb. white paper inserts
- **Acid-free**, lignin-free
- **P.A.T. Certified**
- 50 protectors and inserts per package

| CAT.# | SIZE | LBS. |
|-------------------|-----------|------|
| 38 369 002 | 10" x 11" | 2.70 |

Binder Storage Box

3% calcium carbonate buffer provides safe storage for photos and prints

- Exposed serrated edge to reduce chance of injury
- Shrink-wrapped with polyethylene to preserve archival integrity
- 60-pt. **acid-free**, lignin-free barrier board binder/box; pH of 8.0-9.0
- Hinged lid offers easy access; metal-reinforced edges add stacking strength and durability
- Gray/white box features 2½" spine and 1½" O rings that accept standard three-ring inserts
- **P.A.T. Certified**

| CAT.# | H x W x D | LBS. |
|------------|-----------------|------|
| 38 570 001 | 13" x 12" x 2½" | 1.50 |



Three-Ring Binder Box

Archival-safe protection for prints and photos

- Exposed serrated edge to reduce chance of injury
- Shrink-wrapped with polyethylene to preserve archival integrity
- 60-pt. textured black linen binder is **acid-free** and lignin-free; 8.0-9.0 pH; 3% calcium carbonate buffer
- A Velcro® closure secures flap
- 2" built-in D rings accommodate up to 50 pages
- **P.A.T. Certified**

Same Day Shipping

| CAT.# | H x W x D | LBS. |
|------------|-------------------|------|
| 38 149 001 | 13½" x 12¾" x 2¾" | 1.50 |



Three-Ring Binder with Slip Case

Extend the life of photos with archival-safe binder storage

- Exposed serrated edge to reduce chance of injury
- Shrink-wrapped with polyethylene to preserve archival integrity
- Includes a slip case for extra protection from dust and dirt
- Textured black linen 60-pt. board binder and slip case are **acid-free** and lignin-free; 8.0-9.0 pH; 3% calcium carbonate buffer
- Binder features 2" built-in D rings; brass corners offer protection and an elegant appearance
- **P.A.T. Certified**

| CAT.# | H x W x D | LBS. |
|------------|-------------------|------|
| 38 311 001 | 13¾" x 12¾" x 2¾" | 2.00 |





Slide Storage Pages

Strong continuous seams prevent negative hang-up

- PVC-free polypropylene pages
- Provide safe, long-term storage for 20 35mm mounted transparencies
- Extra heavyweight **10-mil** pages
- 25 pages per package

| CAT.# | DESCRIPTION | H x W | LBS. |
|------------|---------------------------|--|------|
| 38 541 002 | 10-mil Slide Storage Page | 11" x 9 ⁵ / ₁₆ " | 0.68 |

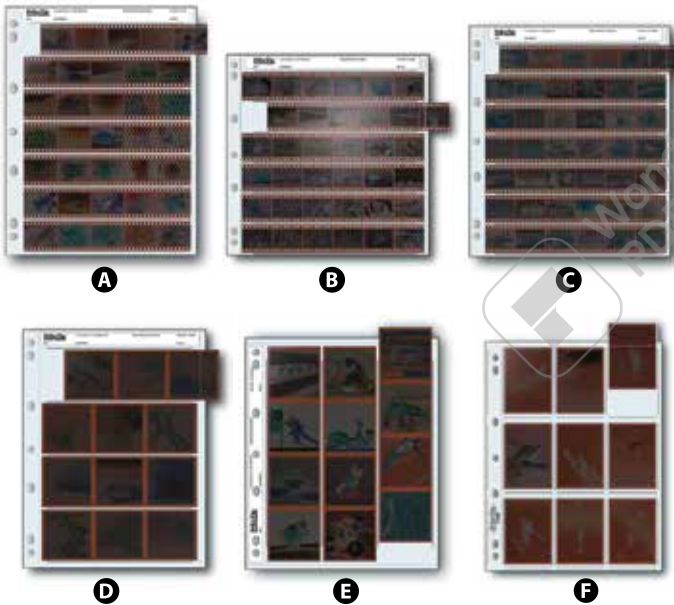

Negative Storage Pages

Exclusive thin backing and high clarity allow you to make quality contact sheets without removing or handling negatives

- PVC-free polyethylene material is safe for long-term storage
- Strong continuous seams prevent negative hang-up
- Top sheets are **3-mil**; bottom sheets are **1.8-mil**
- 25 pages per package

P.A.T. Certified.

35MM NEGATIVE PAGES

| CAT.# | FRAME CAPACITY | H x W | LBS. |
|------------|--------------------------|---|------|
| 38 539 001 | (A) Seven 5-Frame Strips | 11 ³ / ₁₆ " x 8 ⁵ / ₁₆ " | 0.40 |
| 38 539 002 | (B) Six 6-Frame Strips | 9 ³ / ₁₆ " x 10" | 0.35 |
| 38 539 003 | (C) Seven 6-Frame Strips | 11 ⁵ / ₁₆ " x 9 ¹⁵ / ₁₆ " | 0.48 |

120MM NEGATIVE PAGES

| CAT.# | FRAME CAPACITY | H x W | LBS. |
|------------|---------------------------------------|--|------|
| 38 538 001 | (D) Four 12- or 8-Frame Strips | 11 ³ / ₁₆ " x 8 ⁵ / ₁₆ " | 0.40 |
| 38 538 002 | (E) Three 15-, 12-, or 9-Frame Strips | 10 ¹ / ₂ " x 8 ¹⁵ / ₁₆ " | 0.38 |
| 38 538 003 | (F) Nine Individual Frames | 11 ³ / ₁₆ " x 8 ⁵ / ₁₆ " | 0.60 |



Print Size: 3 1/2" x 5"

Print Size: 4" x 6"



Print Size: 5" x 7"

Print Size: 8" x 10"

Album Pages

Pages will not crack or tear and are universal to fit multiple binder styles

- Durable **8-mil** polypropylene archival pages
- Ideal for storing photographs and digital prints
- Choose clear pages or black background to enhance photos
- 25 pages per package

BLACK BACKGROUND

| CAT.# | PRINT SIZE | PRINT CAPACITY | LBS. |
|------------|-------------|----------------|------|
| 38 540 001 | 3 1/2" x 5" | 8 | 0.75 |
| 38 540 002 | 4" x 6" | 6 | 0.75 |
| 38 540 003 | 5" x 7" | 4 | 0.75 |
| 38 540 004 | 8" x 10" | 2 | 0.75 |

CLEAR

| CAT.# | PRINT SIZE | PRINT CAPACITY | LBS. |
|------------|-------------|----------------|------|
| 38 540 101 | 3 1/2" x 5" | 8 | 0.69 |
| 38 540 102 | 4" x 6" | 6 | 0.69 |
| 38 540 103 | 5" x 7" | 4 | 0.69 |
| 38 540 104 | 8" x 10" | 2 | 0.69 |



Six-Pocket Page Protector holds six 4" x 6" photos

Page Protectors and Inserts

Use with 12" x 12" Scrapbooks

- 12 per package
- Inserts are heavyweight stock
- P.A.T. Certified

| CAT.# | DESCRIPTION | LBS. |
|------------|---|------|
| 38 076 001 | Six-Pocket Page Protector (shown above) | 0.60 |
| 38 076 101 | Full Page Protector (4-mil thick) | 0.60 |
| 38 076 201 | White Page Inserts | 0.40 |



Negative and Print Envelopes

Paper stock envelopes feature thumb-cut for easy retrieval

- Choose buffered for brittle or mounted prints
- Choose unbuffered for safe, long-term storage of modern photos and negatives
- 100 per package (except 38 105 005, which is 50 per package)

Specifications

- Acid-free, lignin-free
- pH-neutral adhesive
- P.A.T. Certified

BUFFERED

| CAT.# | SIZE | LBS. |
|------------|--|------|
| 38 104 001 | 4 ³ / ₈ " x 5 ¹ / ₂ " | 1.20 |
| 38 104 002 | 5 ³ / ₈ " x 7 ³ / ₈ " | 1.90 |
| 38 104 003 | 8 ¹ / ₂ " x 10 ¹ / ₂ " | 3.70 |

UNBUFFERED

| CAT.# | SIZE | LBS. |
|-------------|---|------|
| 38 105 001 | 4 ⁷ / ₈ " x 5 ¹ / ₂ " | 1.50 |
| 38 105 002 | 4 ³ / ₈ " x 6 ³ / ₈ " | 1.60 |
| 38 105 003 | 5 ³ / ₈ " x 7 ³ / ₈ " | 2.00 |
| 38 105 004 | 8 ¹ / ₂ " x 10 ¹ / ₂ " | 2.60 |
| 38 105 005* | 11 ¹ / ₂ " x 14 ¹ / ₂ " | 2.00 |

*50 per pkg.



Four-Flap Negative Enclosures

Enclosures adjust to single fold, 1/16" fold, or 1/8" fold to enclose various sizes of negatives or plates

- 7-pt. white unbuffered stock enclosures are prescored for easy creasing
- Store glass and polyester based items emulsion side down; store metal or paper items emulsion side up
- For added protection, cover with acid-free tissue cut to size
- 25 enclosures per package
- P.A.T. Certified

| CAT.# | STORAGE PANEL SIZE | LBS. |
|------------|--|------|
| 38 776 001 | 4 ⁵ / ₈ " x 5 ¹ / ₂ " | 0.50 |
| 38 777 001 | 5 ⁵ / ₈ " x 7 ¹ / ₂ " | 0.85 |
| 38 778 001 | 8 ¹ / ₈ " x 10 ¹ / ₈ " | 2.00 |



Slide Storage Box

Sturdy light cream box includes 20 mini slide boxes to create separate compartments within the storage box itself

- Exposed serrated edge to reduce chance of injury
- Shrink-wrapped with polyethylene to preserve archival integrity
- Storage box is made of acid-free, lignin-free 60-pt. barrier board
- pH of 8.0-9.0, 3% calcium carbonate buffer
- Box features hinged clamshell lid for easy access and metal-reinforced edges for stacking strength and durability
- Mini slide boxes each hold up to twenty 2" x 2" slides, total of 400 slides per box
- P.A.T. Certified

| CAT.# | H x W x D | LBS. |
|------------|---------------|------|
| 38 671 011 | 2" x 11" x 6" | 0.60 |

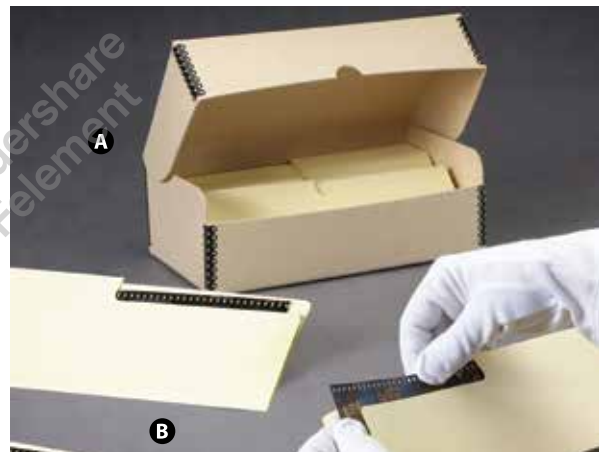

(A) Negative Strip File Box

Provides safe storage for 35mm negatives

- Exposed serrated edge to reduce chance of injury
- Shrink-wrapped with polyethylene to preserve archival integrity
- One-piece box is made of acid-free, lignin-free 60-pt. tan barrier board
- pH of 8.0-9.0, 3% calcium carbonate buffer
- Box features hinged lid for easy browsing and metal-reinforced edges for stacking strength and durability
- For extra protection, place negatives inside sleeves (sold separately below) before storing
- P.A.T. Certified

Same Day Shipping/SafePack

| CAT.# | H x W x D | LBS. |
|------------|---|------|
| 38 531 011 | 3 ¹ / ₂ " x 10 ¹ / ₂ " x 6" | 0.60 |

(B) Negative Strip File Sleeves

File sleeves diminish the stress of handling 35mm negatives and protect them from fingerprint damage

- 3³/₈"H sleeves (B) are made of acid-free 10-pt. cream buffered folder stock
- Sized to fit Negative Strip File Box (sold above)
- 50 sleeves per package
- P.A.T. Certified

| CAT.# | H x W | LBS. |
|------------|--|------|
| 38 532 001 | 3 ³ / ₈ " x 10 ¹ / ₂ " | 0.30 |



Art Profolio



Safe storage for everything from small prints to newspaper spreads

- Albums are **acid-free**, PVC-free, lignin-free
 - Crystal-clear polypropylene pages protect materials from dust, dirt, and fingerprints
 - Each profolio includes 24 top-loading, permanently bound "pocket" pages pre-loaded with black **acid-free** mounting paper
 - **P.A.T. Certified**
- Same Day Shipping**

(A) EVOLUTION PROFOLIOS

| CAT.# | HOLDS PRINT SIZE | LBS. |
|------------|---------------------|------|
| 49 181 001 | 4" x 6" | 0.25 |
| 49 181 006 | 11" x 14" | 1.10 |
| 49 181 007 | 11" x 17" | 2.20 |
| 49 181 008 | 13" x 19" | 1.80 |
| 49 181 010 | 18" x 24" | 4.70 |



(B) ARCHIVAL ART PROFOLIOS

| CAT.# | HOLDS PRINT SIZE | LBS. |
|------------|---------------------|------|
| 49 329 005 | 9" x 12" | 1.00 |
| 49 329 006 | 11" x 14" | 1.50 |
| 49 329 007 | 11" x 17" | 1.80 |
| 49 329 008 | 13" x 19" | 1.80 |
| 49 329 009 | 14" x 17" | 2.00 |
| 49 329 010 | 18" x 24" | 4.70 |

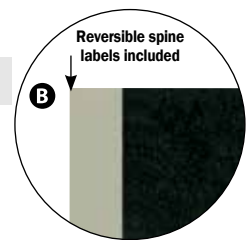

Photo File Box

Protect your 4" x 6" photos against dust, dirt, and damage inside this long-term storage black linen box

- Exposed serrated edge to reduce chance of injury
- Shrink-wrapped with polyethylene to preserve archival integrity
- Features a shallow lid and metal-reinforced edges for stacking strength and durability
- For extra protection, place photos in envelopes or polyester (Mylar) sleeves before storing

Specifications

- 60-pt. black linen board
- **Acid-free**, lignin-free
- 8.0-9.0 pH
- 3% calcium carbonate buffer
- **P.A.T. Certified**

| CAT.# | H x W x D | LBS. |
|------------|---------------|------|
| 49 520 001 | 4" x 6" x 12" | 0.50 |

For Polyester Envelopes & Sleeves,
see pages 22-23.



Divided Photo Storage Box

Long-term storage box features four compartments for organizing your photos

- Exposed serrated edge to reduce chance of injury
- Shrink-wrapped with polyethylene to preserve archival integrity
- Shallow lid and metal-reinforced edges for stacking strength and durability
- Stores up to 1,500 4" x 6" photos loosely in box or up to 740 photos inside photo envelopes (sold separately below)

Specifications

- 60-pt. gray/white barrier board
- **Acid-free**, lignin-free
- 8.0-9.0 pH
- 3% calcium carbonate buffer
- **P.A.T. Certified**

| CAT.# | DESCRIPTION | H x W x D | LBS. |
|------------|-------------------------------|-----------------|------|
| 38 011 012 | Photo Box | 5" x 15½" x 12" | 1.80 |
| 38 011 003 | Photo Envelopes (100/package) | 4" x 6" | 0.80 |



Coroplast™ Portfolios

Lightweight and durable; made of a double-corrugated material that is a copolymer of polypropylene and polyethylene

- pH-neutral, 3-mil, chemically stable portfolios
- Ideal for long-term storage and transportation
- Cut-out front for quick, easy access; built-in handle; latches to keep contents secure

| CAT.# | H x W | LBS. |
|------------|-----------|------|
| 49 295 001 | 14" x 18" | 1.00 |
| 49 295 002 | 17" x 22" | 1.50 |
| 49 295 003 | 23" x 31" | 2.50 |



Drop-Front Digital Print Boxes

Drop-front panel allows easy access to stored digital prints

- Exposed serrated edge to reduce chance of injury
- Shrink-wrapped with polyethylene to preserve archival integrity
- Fully telescoping lid keeps out dust and dirt
- Boxes and lids both feature metal-reinforced edges for stacking strength and durability

Specifications

- 60-pt. barrier board
- Acid-free, lignin-free
- 8.0-9.0 pH
- Black or tan
- 3% calcium carbonate buffer
- P.A.T. Certified

BLACK

| CAT.# | H x W x D | LBS. |
|------------|-------------------|------|
| 38 320 001 | 1½" x 17½" x 11¼" | 1.20 |
| 38 320 002 | 1½" x 18½" x 14½" | 1.50 |
| 38 320 003 | 1½" x 19½" x 13½" | 1.50 |
| 38 320 004 | 1½" x 20½" x 16½" | 1.60 |
| 38 320 005 | 1½" x 24½" x 20½" | 2.30 |
| 38 320 006 | 3" x 10½" x 8½" | 0.80 |
| 38 320 007 | 3" x 19½" x 13½" | 1.60 |

TAN

| CAT.# | H x W x D | LBS. |
|------------|-------------------|------|
| 38 321 001 | 1½" x 17½" x 11¼" | 1.20 |
| 38 321 002 | 1½" x 18½" x 14½" | 1.50 |
| 38 321 003 | 1½" x 19½" x 13½" | 1.50 |
| 38 321 004 | 1½" x 20½" x 16½" | 1.60 |
| 38 321 005 | 1½" x 24½" x 20½" | 2.30 |
| 38 321 006 | 3" x 10½" x 8½" | 0.80 |
| 38 321 007 | 3" x 19½" x 13½" | 1.60 |

Specifications

- 60-pt. barrier board
- 50-pt Tyvek® laminated barrier board
- Acid-free, lignin-free
- 8.0-9.0 pH
- Gray/white or tan
- 3% calcium carbonate buffer
- P.A.T. Certified



Drop-Spine Clamshell Boxes

Safe, long-term storage for oversized documents and prints

- Exposed serrated edge to reduce chance of injury
- Shrink-wrapped with polyethylene to preserve archival integrity
- One-piece box with hinged lid allows easy access to contents
- Choose gray/white or tan boxes, both with metal-reinforced edges for stacking strength and durability
- 50-pt. Tyvek®-laminated barrier board boxes provide excellent tear- and water-resistant properties, along with superior flex-fold strength
- Resist mildew and rot, remain pH-neutral, and are fully recyclable

| CAT.# | DESCRIPTION | H x W x D | LBS. |
|------------|-------------------|------------------|------|
| 38 314 001 | Gray/White | 2" x 19½" x 13½" | 2.00 |
| 38 314 101 | Tyvek® Gray/White | 2" x 19½" x 13½" | 2.00 |
| 38 314 002 | Gray/White | 2" x 24½" x 18½" | 2.50 |
| 38 314 004 | Tan | 2" x 24½" x 18½" | 2.50 |
| 38 314 102 | Tyvek® Gray/White | 2" x 24½" x 18½" | 2.50 |
| 38 314 104 | Tyvek® Tan | 2" x 24½" x 18½" | 2.50 |

Specifications

- B-flute gray stone corrugated board
- Acid-free, lignin-free
- 8.0-9.0 pH
- Acrylic-coated
- 3% calcium carbonate buffer
- P.A.T. Certified



Drop-Front Gallery Boxes

Acrylic-coated to repel moisture

- Two-piece boxes feature drop-front design for easy access and a deep telescoping lid
- All boxes ship flat and ready to assemble

| CAT.# | H x W x D | LBS. |
|------------|------------------|------|
| 49 528 001 | 3" x 10½" x 15½" | 0.88 |
| 49 528 002 | 3" x 20½" x 16½" | 1.40 |
| 49 528 003 | 3" x 24½" x 20½" | 2.80 |
| 49 528 004 | 3" x 31½" x 24½" | 3.00 |



Photo Storage Box

Features a shallow lid and metal-reinforced edges for stacking strength and durability

- Exposed serrated edge to reduce chance of injury
- Shrink-wrapped with polyethylene to preserve archival integrity
- Extend the life of your photos by storing them in this long-term archival-safe black linen box
- For extra protection, place photos in envelopes or polyester (Mylar) sleeves before storing

Specifications

- 60-pt. black linen board
- Acid-free, lignin-free
- 8.0-9.0 pH
- 3% calcium carbonate buffer
- P.A.T. Certified

| CAT.# | H x W x D | LBS. |
|------------|----------------|------|
| 49 509 001 | 5½" x 8" x 11" | 1.80 |



Photo Storage Boxes

Safe for long-term storage, these one-piece boxes feature a hinged lid with flip-top design for easy access

- Exposed serrated edge to reduce chance of injury
- Shrink-wrapped with polyethylene to preserve archival integrity
- Metal-reinforced edges for stacking strength and durability
- For extra protection, place photos in envelopes or polyester (Mylar) sleeves before storing

Specifications

- 60-pt. gray/white barrier board
- Acid-free, lignin-free
- 8.0-9.0 pH
- 3% calcium carbonate buffer
- P.A.T. Certified

| CAT.# | H x W x D | LBS. |
|------------|-----------------|------|
| 38 372 001 | 5" x 6" x 2½" | 0.40 |
| 38 372 002 | 5¾" x 7¾" x 4½" | 0.40 |

Quake Hold! Museum Wax and Gel

Safeguard collections against earthquakes, routine dusting, or patron accident

- Non-acidic, non-toxic, and reversible
- Museum Wax is soft and sticky to allow maximum flexibility
- Museum Gel is crystal-clear and suitable for glass and crystal

Note: Use on non-porous objects only. Gel contains silicone that may stain porous materials.

Same Day Shipping

| CAT.# | DESCRIPTION | SIZE | LBS. |
|------------|-------------|--------|------|
| 38 021 001 | Museum Wax | 13 oz. | 0.80 |
| 38 128 001 | Museum Gel | 4 oz. | 0.10 |



Wishab Sponge

Rubs easily over soiled area and forms crumbs that can be brushed off or vacuumed

- Latex sponge is an excellent tool for removing dust and soot from paintings and murals
- Vulcanized sponge is pH-neutral and leaves no residue

Same Day Shipping

| CAT.# | H x W x D | LBS. |
|------------|-----------------|------|
| 55 542 001 | 1¾" x 3¾" x 2½" | 0.15 |



Specifications

- B-flute gray stone corrugated board
- Acid-free, lignin-free
- 8.0-9.0 pH
- 3% calcium carbonate buffer
- P.A.T. Certified

Protective Frame Corners

Acid-free corners fit frames from 1" - 2" thick

- Constructed of heavy-duty corrugated board
- Sturdy corners protect frames from nicks and scratches during storage or transport
- 48 corners per package

Assembled.

| CAT.# | LBS. |
|------------|------|
| 38 718 001 | 1.70 |



Dexter Mat Cutter

Perfect for scoring cardboard or illustration board

- Allows you to cut mats of any thickness with a straight cut or a professional beveled edge
- Features a chrome-plated metal body that fits comfortably in the hand and a plastic knob that allows blade adjustment for any angle or depth
- Instructions included



| CAT.# | DESCRIPTION | LBS. |
|------------|-----------------------------|------|
| 42 305 001 | Cutter | 0.80 |
| 42 305 101 | Replacement Blades (5-pack) | 0.10 |

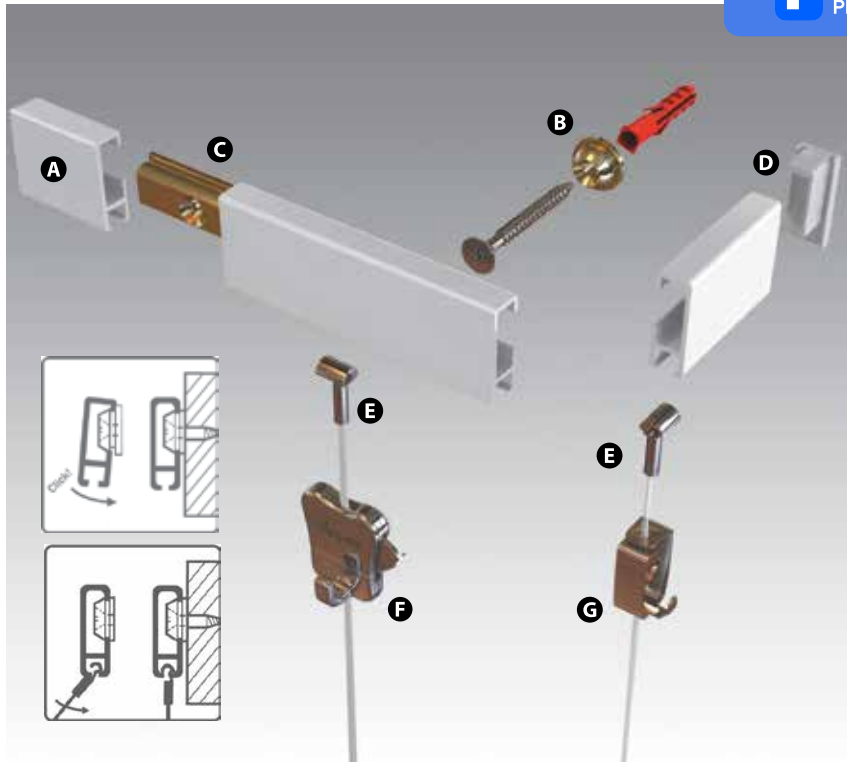

Hang It Up Systems

Offers complete flexibility to reshuffle wall arrangements without touching or defacing the wall

- The most effective system devised for hanging pictures or exhibits
- With the inconspicuous track installed, hangings can be arranged as needed
- Aluminum hanging system is thick-walled and super strong; can be easily upgraded to incorporate a lighting system (call for details)



(A) CLIPRAIL 2 TRACK

- Strong aluminum rail can easily be cut to fit shorter spaces or joined to create a larger hanging area
- Track snaps on to brass clip as shown in insets above

| CAT.# | LENGTH | LBS. |
|---------|------------|------|
| 38 870* | 78" (6.5') | 1.05 |

*Specify color below.



White-001

Silver-002

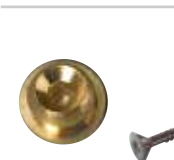

(B) MOUNTING HARDWARE

- Use to mount track to wall at approximately 12" intervals
- Order one clip, screw, and plug for every 12" of rail purchased

| CAT.# | DESCRIPTION | LBS. |
|------------|-------------|------|
| 38 872 001 | Brass Clip | 0.01 |
| 38 873 001 | Screw | 0.01 |
| 38 874 001 | Plug | 0.01 |



(C) TRACK (STRAIGHT) CONNECTOR

- Connects two pieces of cliprail track when creating a continuous hanging area

| CAT.# | DESCRIPTION | LBS. |
|------------|-----------------|------|
| 38 875 001 | Brass Connector | 0.02 |

(D) END-CAP

- Snaps on easily for neat termination of exposed cliprail ends

| CAT.# | LBS. |
|---------|------|
| 38 876* | 0.01 |

*Specify color below.



White-001

Silver-002



Perlon® Steel

(E) HANGERS

- Choose clear Perlon® cord or stainless steel cable with cobra heads
- Both click easily into rail at any point as shown in insets above, then slide along to the desired position

| CAT.# | LENGTH | LBS. |
|---------|-------------|------|
| 38 878* | 39" (3.25') | 0.04 |
| 38 879* | 59" (4.9') | 0.04 |
| 38 880* | 78" (6.5') | 0.04 |
| 38 881* | 98" (8.1') | 0.04 |

*Specify material: Perlon®-001 or Steel-002.



(F & G) ADJUSTABLE HOOKS

- Choose from two hook types, depending on weight and level of security required
- Zipper Hook (F) is a heavy-duty self-locking hook; when used with Perlon® cord, holds up to 22 lbs.; with steel cable, holds up to 33 lbs.
- SmartSpring Hook (G) adjusts easily with pinch action; for use with Perlon® cord only; holds up to 9 lbs.



| CAT.# | DESCRIPTION | LBS. |
|------------|----------------------|------|
| 38 883 001 | (F) Zipper Hook | 0.04 |
| 38 884 001 | (G) SmartSpring Hook | 0.01 |



Corrugated Textile Storage Boxes

Sturdy board boxes provide safe, long-term storage for valuable fabrics, textiles, or artifacts

- Boxes offer protection from dust and dirt and feature a shallow lid for easy access
 - Choose uncoated or acrylic-coated to repel moisture
 - For added protection, fill and wrap clothing and fabrics in tissue before storing
- Ships flat and ready to assemble.

Specifications

- B-flute gray stone corrugated board
- Acid-free, lignin-free
- 8.0-9.0 pH
- 3% calcium carbonate buffer
- P.A.T. Certified

ACRYLIC COATED

| CAT.# | H x W x D | LBS. |
|------------|----------------|------|
| 49 371 001 | 6" x 18" x 30" | 3.00 |
| 49 371 002 | 6" x 18" x 40" | 3.50 |

UNCOATED

| CAT.# | H x W x D | LBS. |
|------------|----------------|------|
| 49 371 101 | 6" x 18" x 30" | 3.00 |
| 49 371 102 | 6" x 18" x 40" | 3.50 |



Flag Storage Box

Heavy-duty triangular-shaped corrugated board box has self-locking lid to keep flag secure and free from deterioration

- Acrylic-coated to protect flag from damage due to moisture

Ships flat and ready to assemble.

Specifications

- B-flute gray stone corrugated board
- Acid-free, lignin-free
- 8.0-9.0 pH
- 3% calcium carbonate buffer
- P.A.T. Certified

| CAT.# | H x W x D | LBS. |
|------------|------------------|------|
| 49 539 001 | 3" x 22½" x 15¾" | 0.64 |

Cloth Labeling Tape

White cotton twill tape is ideal for labeling fabrics and textiles for easy identification

- Tape can also be used to wrap or tie textiles
- When labeling, use with permanent acid-free washable Pigma Pens (sold on page 31)
- It is recommended that you use a very fine needle and polyester thread when sewing tape to garments or other textiles



Same Day Shipping

| CAT.# | SIZE | LBS. |
|------------|---------------|------|
| 42 095 001 | 1"H x 72 yds. | 1.00 |

Textile Storage Boxes

Keep costumes, wedding gowns, and other treasured textiles safe from dust and dirt

- Exposed serrated edge to reduce chance of injury
- Shrink-wrapped with polyethylene to preserve archival integrity
- Designed for long-term storage, these two-piece boxes feature a deep telescoping lid
- Boxes and lids have metal-reinforced edges for stacking strength and durability
- For extra protection, fill and wrap clothing and fabrics in tissue before storing



Specifications

- 60-pt. gray/white barrier board
- Acid-free, lignin-free
- 8.0-9.0 pH
- 3% calcium carbonate buffer
- P.A.T. Certified

| CAT.# | H x W x D | LBS. |
|------------|--------------------|------|
| 38 371 001 | 6" x 18" x 30" | 3.50 |
| 49 184 001 | 10¾" x 18¾" x 30½" | 4.00 |



Hat Storage Box

Two-piece box allows safe long-term storage and features a shallow lid for easy access

- Exposed serrated edge to reduce chance of injury
- Shrink-wrapped with polyethylene to preserve archival integrity
- Choose matching gray lid or transparent 30-gauge polypropylene lid for easy content identification
- Both lid and box have metal-reinforced edges for durability and extra stacking strength (12"H x 13½"W x 13¾"D). **Same Day Shipping/SafePack**

Specifications

- 60-pt. gray/white barrier board
- Acid-free, lignin-free
- 8.0-9.0 pH
- 3% calcium carbonate buffer
- P.A.T. Certified

| CAT.# | DESCRIPTION | LBS. |
|------------|--------------------------|------|
| 32 377 001 | Box with Gray Lid | 2.16 |
| 32 377 002 | Box with Transparent Lid | 2.16 |

Shoe Box

Corrugated board box provides safe, long-term storage and features an acrylic coating that protects contents from damage due to moisture

- This box is also great for artifact storage
 - The unique locking 30-pt. polypropylene shallow lid is clear for easy content identification and features metal-reinforced edges for extra stacking strength
- Ships flat and ready to assemble.



Specifications

- B-flute gray stone corrugated board
- Acid-free, lignin-free
- 8.0-9.0 pH
- 3% calcium carbonate buffer
- P.A.T. Certified

| CAT.# | H x W x D | LBS. |
|------------|----------------|------|
| 49 176 001 | 5½" x 13" x 8" | 0.80 |

Artifact Carton and Trays

Sturdy, heavy-duty carton

- Individual compartment trays hold small to medium-sized objects
- Metal edges for durability and stacking strength
- Carton ships flat and ready to assemble

Specifications

- Buffered corrugated board
- Acid-free, lignin-free
- 8.0-9.0 pH
- 3% calcium carbonate buffer
- P.A.T. Certified

| CAT.# | DESCRIPTION | COMPARTMENT H x W x D | LBS. |
|------------|-------------------------|--------------------------|------|
| 49 541 001 | Storage Carton with Lid | 10" x 12" x 15" | 1.30 |
| 49 542 001 | 4-Compartment Tray | 5" x 5 1/4" x 7 1/4" | 0.90 |
| 49 542 002 | 6-Compartment Tray | 2 1/2" x 5 1/4" x 4 1/4" | 0.70 |
| 49 542 003 | 15-Compartment Tray | 2 1/2" x 3 1/4" x 2 1/4" | 0.80 |



Clear Artifact Storage Boxes

Translucent boxes allow a clear view of stored contents, while metal-reinforced edges add stacking strength and durability

- Exposed serrated edge to reduce chance of injury
- Shrink-wrapped with polyethylene to preserve archival integrity
- Two-piece boxes feature deep telescoping lids to offer protection from dust, dirt, and damage
- Tops and bottoms may also be used separately as storage trays in flat file drawers or cabinets

Specifications

- 30-gauge polypropylene
- Acid-free
- P.A.T. Certified

| CAT.# | H x W x D | LBS. |
|------------|--------------------------|------|
| 45 525 101 | 1 3/4" x 2 3/4" x 2 1/2" | 0.10 |
| 45 525 102 | 1 3/4" x 3 3/4" x 4" | 0.10 |
| 45 525 103 | 1 1/2" x 4 3/4" x 6 1/2" | 0.13 |
| 45 525 104 | 1 1/2" x 5 3/4" x 7 1/2" | 0.13 |



Artifact Storage Boxes

Tops and bottoms may also be used separately as storage trays in flat file drawers or cabinets

- Sturdy two-piece boxes with deep telescoping lids offer safe long-term storage for jewelry, buttons, other small artifacts, or printed materials
- Metal-reinforced edges add durability and stacking strength for increased storage capacity

Specifications

- 60-pt. tan barrier board
- Acid-free, lignin-free
- 8.0-9.0 pH
- 3% calcium carbonate buffer
- P.A.T. Certified

| CAT.# | H x W x D | LBS. |
|------------|--------------------------|------|
| 49 525 001 | 1 3/4" x 2 3/4" x 2 1/2" | 0.10 |
| 49 525 002 | 1 3/4" x 3 3/4" x 4" | 0.10 |
| 49 525 003 | 1 1/2" x 4 3/4" x 6 1/2" | 0.13 |
| 49 525 004 | 1 1/2" x 5 3/4" x 7 1/2" | 0.13 |



Artifact ID Tags

Acid-free, lignin-free ID tags have a pH of 8.5

- Can be used to safely label all archival materials
- Made of tan buffered folder stock, tags include a 12" string (6" after folding for tag loop) for attaching to artifacts
- 100 tags per package



| CAT.# | H x W | LBS. |
|------------|-----------------|------|
| 49 575 001 | 3/4" x 3/4" | 1.00 |
| 49 575 002 | 1 1/2" x 3 3/4" | 1.00 |

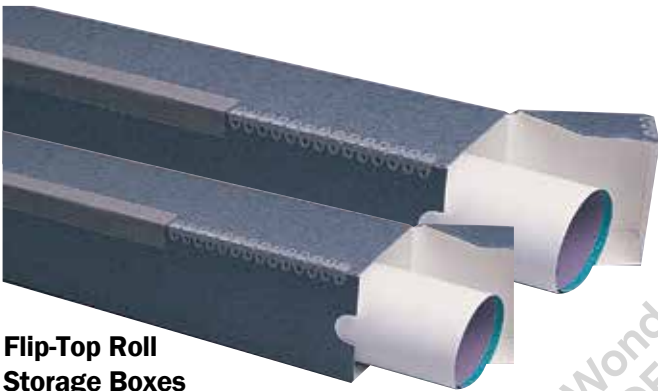

Flip-Top Roll Storage Boxes

Boxes feature square construction with metal-reinforced and taped edges

- Exposed serrated edge to reduce chance of injury
- Shrink-wrapped with polyethylene to preserve archival integrity
- Durability and stacking strength
- Flip-top lids allow easy access to rolled contents

Specifications

- 60-pt. gray/white barrier board
- **Acid-free**, lignin-free
- 8.0-9.0 pH
- 3% calcium carbonate buffer
- **P. A. T. Certified**

| CAT.# | SIZE | LBS. |
|------------|--------------|------|
| 38 364 001 | 4" sq. x 30" | 0.90 |
| 38 364 002 | 5" sq. x 37" | 1.00 |

Polypropylene Foam Roll

Ideal for lining steel shelving or exhibit cases

- Soft, non-abrasive, waterproof 1/4"-thick foam
- Can also be used to wrap around fragile items prior to storing or transporting



| CAT.# | W x L | LBS. |
|------------|------------|------|
| 38 639 001 | 12" x 250' | 8.00 |



SafeCare® Storage Tubes

Offers archival-safe storage for rolled maps, blueprints, drawings, and posters

- **Acid-free**, lignin-free buffered board tubes are 3" and 6" in diameter with 3/16"-thick walls
 - Rolls also feature a pH of 8.5 and layers that are bonded with pH-neutral PVA adhesive for safe long-term storage of textiles, carpets, tapestries, quilts, and more
 - Polypropylene caps sold separately below
- Ships from manufacturer.

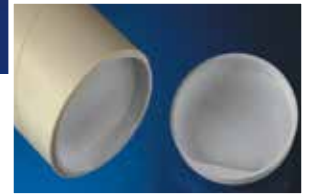

| CAT.# | TUBES PER PACK | INSIDE DIAMETER x L | LBS. |
|-------------|----------------|----------------------------|--------|
| 49 815 001 | 10 | 3" x 2' | 15.00 |
| 49 815 002 | 10 | 3" x 3' | 19.00 |
| 49 815 003 | 10 | 3" x 4' | 31.00 |
| 49 815 004* | 10 | 3" x 6' | 38.00 |
| 49 815 005* | 10 | 3" x 8' | 50.00 |
| 49 815 006* | 10 | 3" x 10' | 82.00 |
| 49 815 007* | 10 | 3" x 12' | 100.00 |
| 49 816 001 | 2 | 6" x 2' | 9.60 |
| 49 816 002 | 2 | 6" x 3' | 11.60 |
| 49 816 003 | 2 | 6" x 4' | 14.40 |
| 49 816 004* | 2 | 6" x 6' | 21.20 |
| 49 816 005* | 2 | 6" x 8' | 30.40 |
| 49 816 006* | 2 | 6" x 10' | 42.40 |
| 49 816 007* | 2 | 6" x 12' | 45.20 |
| 49 817 001 | 20 pk. | Caps for 3" Diameter Tubes | 1.00 |
| 49 817 002 | 2 pk. | Caps for 6" Diameter Tubes | 0.20 |

*Ships via truck.



Roll Storage Boxes

Versatile boxes open two ways – lengthwise and on the end – providing convenient access to delicate materials

- Heavy-duty pyramidal construction provides stacking strength
- Acrylic-coated board repels moisture
- Boxes ship flat and ready to assemble

Specifications

- B-flute gray stone corrugated board
- **Acid-free**, lignin-free
- 8.0-9.0 pH
- 3% calcium carbonate buffer
- **P. A. T. Certified**

ACRYLIC COATED

| CAT.# | SIZE | LBS. |
|------------|----------|------|
| 49 549 001 | 5" x 24" | 1.00 |
| 49 549 002 | 6" x 38" | 2.00 |
| 49 549 003 | 6" x 49" | 2.50 |

UNCOATED

| CAT.# | SIZE | LBS. |
|------------|----------|------|
| 49 549 101 | 5" x 24" | 1.00 |
| 49 549 102 | 6" x 38" | 2.00 |
| 49 549 103 | 6" x 49" | 2.50 |



Sheet Music Folders

Protect and separate individual sheet music during storage

- 10-pt. **acid-free**, lignin-free folders
- For long-term storage, these Sheet Music Folders fit into the Sheet Music Boxes (sold below)
- 10 folders per package

P.A.T. Certified.

| CAT.# | H x W | LBS. |
|-------------------|--|------|
| 38 501 001 | 12 $\frac{3}{4}$ " x 9 $\frac{1}{2}$ " | 0.60 |
| 38 501 002 | 15" x 12" | 0.60 |



Postcard Box

Two-piece long-term storage box keeps postcards and other valued collections safe from dust, dirt, and damage

- Exposed serrated edge to reduce chance of injury
- Shrink-wrapped with polyethylene to preserve archival integrity
- Shallow lid allows easy access
- Metal-reinforced edges add durability and extra stacking strength for increased storage capability (0.90 lbs.)

Specifications

- 60-pt. gray/white barrier board
- **Acid-free**, lignin-free
- 8.0-9.0 pH
- 3% calcium carbonate buffer
- **P. A. T. Certified**

| CAT.# | H x W x D |
|-------------------|---|
| 49 535 002 | 4 $\frac{1}{2}$ " x 12" x 6 $\frac{1}{2}$ " |



Sheet Music Boxes

Boxes feature a drop-front design for easy access

- Exposed serrated edge to reduce chance of injury
- Shrink-wrapped with polyethylene to preserve archival integrity
- Deep telescoping lid guards stored sheet music against dust, dirt, and damage
- Metal-reinforced edges provide stacking strength and durability

Specifications

- 60-pt. gray/white barrier board
- **Acid-free**, lignin-free
- 8.0-9.0 pH
- 3% calcium carbonate buffer
- **P. A. T. Certified**

| CAT.# | H x W x D | LBS. |
|-------------------|--|------|
| 49 390 001 | 3" x 10 $\frac{1}{2}$ " x 13 $\frac{1}{2}$ " | 0.50 |
| 49 391 001 | 3" x 13" x 16" | 0.60 |



Hinged-Lid Storage Boxes

Corrugated one-piece hinged-lid boxes are perfect for safe long-term storage of metal, wood, plastic, and ceramic artifacts

- Choose acrylic-coated to repel moisture or uncoated
- For extra cushioning and protection, line boxes with tissue or foam
- Boxes ship flat and ready to assemble

Same Day Shipping

ACRYLIC COATED

| CAT.# | H x W x D | LBS. |
|-------------------|----------------|------|
| 49 529 002 | 5" x 12" x 10" | 1.30 |
| 49 529 004 | 5" x 20" x 16" | 1.60 |

UNCOATED

| CAT.# | H x W x D | LBS. |
|-------------------|--|------|
| 49 529 101 | 3" x 17 $\frac{1}{2}$ " x 11 $\frac{1}{2}$ " | 1.20 |
| 49 529 104 | 5" x 20" x 16" | 1.60 |

Specifications

- B-flute corrugated board
- **Acid-free**, lignin-free
- 8.0-9.0 pH
- 3% calcium carbonate buffer
- **P. A. T. Certified**

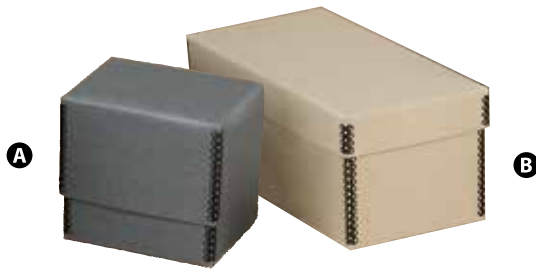

Disc Storage Boxes

Metal edged for stacking

- Exposed serrated edge to reduce chance of injury
- Shrink-wrapped with polyethylene to preserve archival integrity
- 4½"D boxes hold up to 10 single CDs in jewel cases or 50 CDs in Tyvek® sleeves
- 12"D boxes hold up to 26 single CDs in jewel cases or 133 CDs in Tyvek® sleeves (sold separately)

Same Day Shipping/SafePack

| CAT.# | DESCRIPTION | H x W x D |
|------------|---------------------------|-----------------|
| 38 374 001 | (A) Gray/White Hinged Lid | 5½" x 6" x 4½" |
| 38 374 100 | (B) Tan Two Piece Lid | 5½" x 5½" x 12" |
| 38 374 200 | Black Two Piece Lid | 5½" x 5½" x 12" |

Specifications

- 60-pt. tan, gray/white, or black barrier board
- Acid-free, lignin-free
- 8.0-9.0 pH
- 3% calcium carbonate buffer
- P.A.T. Certified

Dividers with Index Tabs

- 5"H x 5½"W buffered cream stock divider cards feature heavy-duty attached Mylar index tabs (two each red, blue, green, yellow, and orange)
- 10 cards per package

Same Day Shipping

| CAT.# | LBS. | PRICE |
|------------|------|--------|
| 38 452 001 | 0.25 | \$8.42 |

Shallow Lid Box



Specifications

- 40-pt. tan barrier board
- Acid-free, lignin-free
- 8.0-9.0 pH
- 3% calcium carbonate buffer
- P.A.T. Certified

Microfilm Reels

Reels feature a 100' capacity and a flange that holds film firmly in place

- Acid-free, high-impact ABS plastic reels
- Offers safe storage for your expanding microfilm collection

Same Day Shipping

| CAT.# | DESCRIPTION | LBS. |
|------------|-----------------------|------|
| 83 095 001 | 16mm Open Flange Reel | 0.40 |
| 83 096 001 | 35mm Open Flange Reel | 0.50 |



Specifications

- 10-pt. buffered light tan PermaDur®
- Acid-free, lignin-free
- 8.5 pH
- P.A.T. Certified

Microfilm Reel Loop and Button Reel ID Tags

Tags offer sufficient space for lettering and numbering

- Button loop prevents 35mm film from unraveling on the reel
- 100 tags per package

Same Day Shipping

| CAT.# | H x W | LBS. |
|------------|-----------|------|
| 49 086 001 | 1½" x 12" | 0.60 |



Microfiche Divider Guides

Safely divide and organize your fiche collection

- Acid-free, lignin-free dividers
- Choose full-cut or half-cut 20-pt. cream stock dividers
- 50 divider guides/separators per package
- P.A.T. Certified



| CAT.# | DESCRIPTION | H x W | LBS. |
|------------|-----------------------------|----------|------|
| 49 080 001 | Full-Cut 20-pt. Cream Stock | 4½" x 6" | 1.10 |
| 49 080 002 | Half-Cut 20-pt. Cream Stock | 4½" x 6" | 0.94 |

Microfiche Boxes

Tan barrier board boxes for 4" x 6" microfiche storage

- Exposed serrated edge to reduce chance of injury
- Shrink-wrapped with polyethylene to preserve archival integrity
- Large two-piece box with shallow lid safely stores up to (600) 4" x 6" fiche in envelopes
- Metal-reinforced edges for stacking strength and durability

Same Day Shipping/SafePack

| CAT.# | H x W x D | LBS. |
|------------|-----------------|------|
| 85 405 001 | 4¾" x 6¾" x 12" | 1.10 |

High Throat Microfiche Envelopes

Seamed outside edges offer a smooth, abrasive-free surface

- Acid-free, lignin-free, buffered paper envelopes protect fiche from dust, dirt, and damage
- Envelopes fit easily into 4" x 6" microfiche box; 500 envelopes per package
- P.A.T. Certified



| CAT.# | H x W |
|------------|-----------|
| 49 003 001 | 4½" x 6¾" |

Specifications

- 60-pt. gray/white or black barrier board
- Acid-free, lignin-free
- 8.0-9.0 pH
- 3% calcium carbonate buffer
- P.A.T. Certified



Phonograph Storage Boxes

Each box holds up to 45 records

- Exposed serrated edge to reduce chance of injury
- Shrink-wrapped with polyethylene to preserve archival integrity
- Long-term storage boxes keep fragile phonograph records safe from scratches and fingerprints
- Sturdy boxes and hinged flip-top lids feature metal-reinforced edges for stacking strength and durability
- For extra protection, place records in sleeves (sold separately below) before storing



| CAT.# | HOLDS | COLOR | H x W x D |
|-------------------|-------------|------------|----------------|
| 38 289 001 | 7" Records | Gray/White | 8" x 7½" x 7" |
| 38 440 001 | 7" Records | Black | 8" x 7½" x 7" |
| 38 384 001 | 12" Records | Gray/White | 13" x 13" x 6" |
| 38 384 002 | 12" Records | Black | 13" x 13" x 6" |

Record Storage Sleeves

Protect valuable records from fingerprints and damage

- 10-pt. cream folder stock sleeves
- Sleeves are acid-free and lignin-free
- pH level of 8.0-8.5; 3% calcium carbonate buffer
- Choose sleeves with die-cut center opening (not shown) to display record label or sleeves with flap closure and no center opening
- 25 sleeves per package
- P.A.T. Certified

WITH CENTER OPENING AND NO FLAP CLOSURE

| CAT.# | H x W |
|-------------------|------------|
| 38 291 001 | 7" x 7" |
| 38 291 002 | 10" x 10½" |
| 38 291 003 | 12" x 12½" |

WITH FLAP CLOSURE AND NO CENTER OPENING

| CAT.# | H x W |
|-------------------|-----------|
| 38 292 002 | 13" x 13" |



Drop-Front VHS Storage Boxes

Heavy-duty corrugated box features drop-front panel and hinged lid for easy access

- Exposed serrated edge to reduce chance of injury
- Shrink-wrapped with polyethylene to preserve archival integrity
- Choose acrylic-coated to repel moisture or uncoated

Ships flat and ready to assemble. (8"H x 4¾"W x 24"D)

Specifications

- B-flute gray stone corrugated board
- Acid-free, lignin-free
- 8.0-9.0 pH
- 3% calcium carbonate buffer
- P.A.T. Certified

| CAT.# | DESCRIPTION | LBS. |
|-------------------|-------------|------|
| 32 378 001 | Coated | 1.00 |
| 32 378 101 | Uncoated | 1.00 |

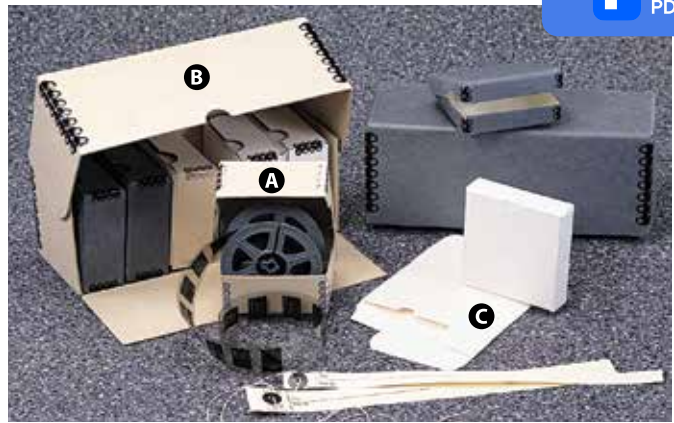

Microfilm Storage Boxes

Protect 16mm and 35mm microfilm reels from dust, dirt, and damage during handling and storage

- Acid-free, lignin-free, buffered board stock boxes
- All boxes except (C) "Pop-Up" box feature metal edges for added stacking strength and durability
- P.A.T. Certified
- Same Day Shipping

(A) MICROFILM INDIVIDUAL HINGED LID STORAGE BOXES

- 35mm box measures 1½"H x 3¾"W x 3¾"D
- 16mm box measures ¾"H x 3¾"W x 3¾"D

| CAT.# | DESCRIPTION | LBS. |
|-------------------|---|------|
| 38 437 001 | 40-pt. Tan Board for 35mm | 0.12 |
| 38 437 202 | 60-pt. White Board with Blue/Gray Interior for 16mm | 0.07 |

(B) MICROFILM STORAGE CASES

- 10½"D case stores six 35mm boxes or eleven 16mm boxes
- 14¾"D case stores eight 35mm boxes

| CAT.# | DESCRIPTION | H x W x D | LBS. |
|-------------------|------------------------|------------------|------|
| 39 502 101 | 60-pt. Blue/Gray Board | 4¾" x 4¾" x 10½" | 0.40 |
| 39 502 102 | 60-pt. Blue/Gray Board | 4¾" x 4¾" x 14¾" | 0.40 |

(C) ECONOMY MICROFILM REEL "POP-UP" BOX

- White buffered archival board with pH of 8.5
- Ships flat and "pops up" for easy assembly; 100 per package

| CAT.# | DESCRIPTION | LBS. |
|-------------------|-----------------|------|
| 38 996 001 | Holds 35mm Film | 5.90 |

Specifications

- 60-pt. gray/white barrier board
- Acid-free, lignin-free
- 8.0-9.0 pH
- 3% calcium carbonate buffer
- P.A.T. Certified



VHS and Audiocassette Storage Boxes

Two-piece gray/white storage boxes feature metal-reinforced edges that add stacking strength and durability for long-term storage

- Exposed serrated edge to reduce chance of injury
- Shrink-wrapped with polyethylene to preserve archival integrity
- VHS Box has a shallow lid to protect up to 12 videocassettes in their original cases
- Audiocassette Box has a deep telescoping lid to protect up to 36 audiocassettes from dirt and dust

| CAT.# | DESCRIPTION | H x W x D | LBS. |
|-------------------|---------------------------|-----------------|------|
| 32 396 001 | VHS Storage Box | 5" x 15½" x 8½" | 1.01 |
| 32 376 001 | Audiocassette Storage Box | 3" x 12½" x 9½" | 0.96 |



Two Ten-Drawer Flat Files with optional Closed Base

One Medium Five-Drawer Flat File with optional Open Base

Steel Flat Files

Safely store maps, blueprints, building plans, or documents

- Archival-safe secure files with heavy-gauge steel frames and front supports
- Stackable up to five high on closed base
- Anti-slip pads keep files in place when stacked
- Drawers feature extra-strength rails, heavy steel side roller assembly, and steel ball-bearing rollers for smooth operation without jamming
- Drawers include label holders and chrome handles
- Safety stop prevents drawers from being pulled out
- Front depressors prevent sheets of paper from curling
- Five-drawer file has 2"H drawers; 10-drawer file has 1"H drawers
- Call for custom colors (upcharge)

Assembled. Ships from manufacturer via truck.

SMALL FIVE-DRAWER FLAT FILE

Overall dimensions: 16½"H x 40¾"W x 29¾"D.
Inside drawer dimensions: 2¾"H x 37"W x 26"D.

| CAT.# | DESCRIPTION | LBS. |
|-------------|-----------------|--------|
| 87 100 000* | Small Flat File | 160.00 |
| 87 102 000* | 6"H Closed Base | 22.00 |
| 87 103 000* | 20"H Open Base | 39.00 |

*Specify color below.

MEDIUM FIVE-DRAWER FLAT FILE

Overall dimensions: 16½"H x 46¾"W x 35¾"D.
Inside drawer dimensions: 2¾"H x 43"W x 32"D.

| CAT.# | DESCRIPTION | LBS. |
|-------------|------------------|--------|
| 87 105 000* | Medium Flat File | 195.00 |
| 87 107 000* | 6"H Closed Base | 26.00 |
| 87 108 000* | 20"H Open Base | 43.00 |

*Specify color below.

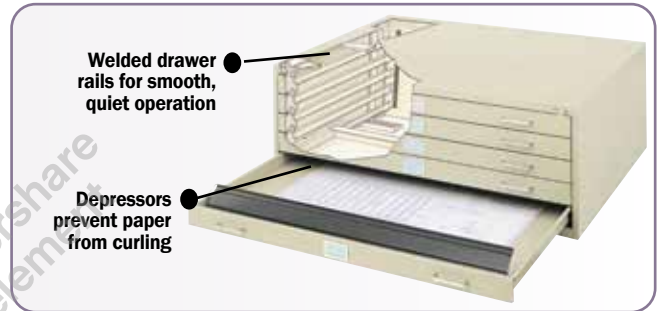

LARGE FIVE-DRAWER FLAT FILE

Overall dimensions: 16½"H x 53½"W x 41½"D.
Inside drawer dimensions: 2¾"H x 50"W x 38"D.

| CAT.# | DESCRIPTION | LBS. |
|-------------|-----------------|--------|
| 87 110 000* | Large Flat File | 250.00 |
| 87 112 000* | 6"H Closed Base | 30.00 |
| 87 113 000* | 20"H Open Base | 48.00 |

*Specify color below.

TEN-DRAWER FLAT FILE

Overall dimensions: 16½"H x 46¾"W x 35¾"D.
Inside drawer dimensions: 1¾"H x 43"W x 32"D.

| CAT.# | DESCRIPTION | LBS. |
|-------------|------------------------------------|--------|
| 87 133 000* | Flat File (not available in White) | 278.00 |
| 87 107 000* | 6"H Closed Base | 26.00 |
| 87 108 000* | 20"H Open Base | 43.00 |

*Specify color below.

LOCK KIT - For extra security. (1.00 lb.)

| CAT.# | DRAWERS |
|------------|---------|
| 87 115 004 | 5 |
| 87 115 005 | 10 |

STANDARD COLORS:



CUSTOM COLORS; CALL FOR PRICING:

